

AME SURGICAL INSTRUMENTS

Scissors



- OPERATING SCISSORS
- PLASTER SHEARS

- MICRO SCISSORS
- T.C. SCISSORS

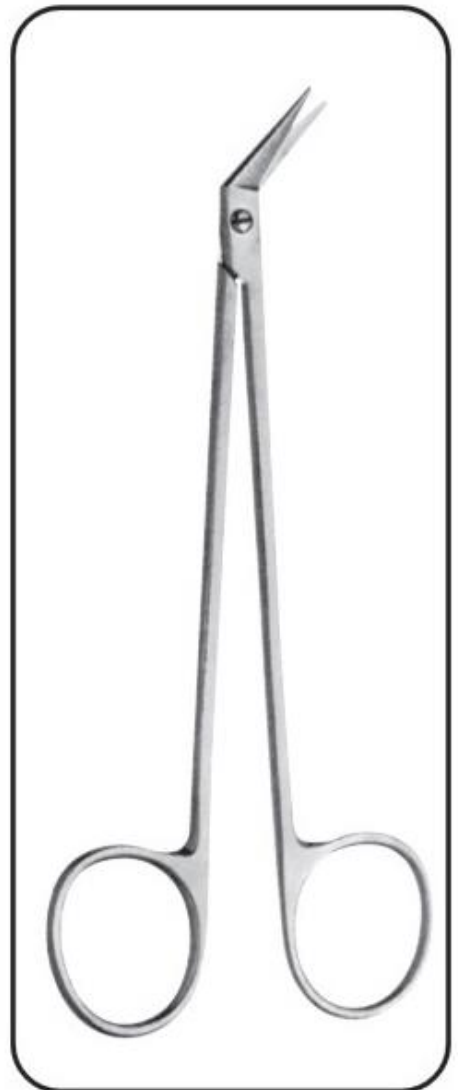
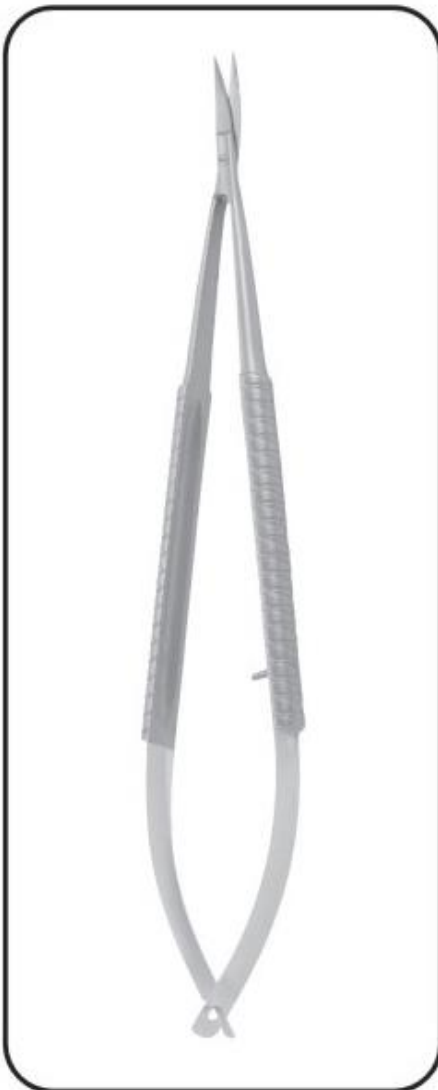

Operating Scissors

ROUND PATTERN

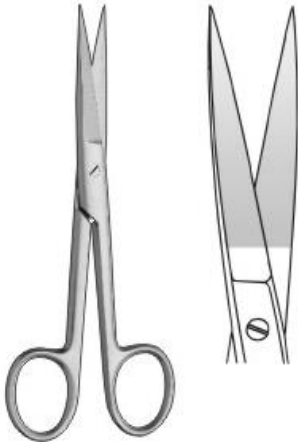

STANDARD STRAIGHT
15-001-115 11.5 cm, 4 1/2"
15-002-130 13.0 cm, 5"
15-003-140 14.0 cm, 5 1/2"
15-004-150 15.0 cm, 6"
15-005-160 16.0 cm, 6 1/4"
15-006-175 17.5 cm, 7"
15-007-185 18.5 cm, 7 1/4"
15-008-200 20.0 cm, 8"
 S/S Str.

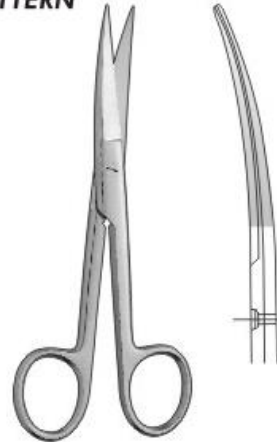

STANDARD CURVED
15-009-115 11.5 cm, 4 1/2"
15-010-130 13.0 cm, 5"
15-011-140 14.0 cm, 5 1/2"
15-012-150 15.0 cm, 6"
15-013-160 16.0 cm, 6 1/4"
15-014-175 17.5 cm, 7"
15-015-185 18.5 cm, 7 1/4"
15-016-200 20.0 cm, 8"
 S/S Cvd.

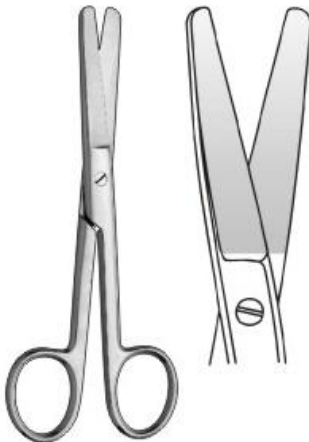

STANDARD STRAIGHT
15-017-115 11.5 cm, 4 1/2"
15-018-130 13.0 cm, 5"
15-019-140 14.0 cm, 5 1/2"
15-020-150 15.0 cm, 6"
15-021-160 16.0 cm, 6 1/4"
15-022-175 17.5 cm, 7"
15-023-185 18.5 cm, 7 1/4"
15-024-200 20.0 cm, 8"
 B/B Str.

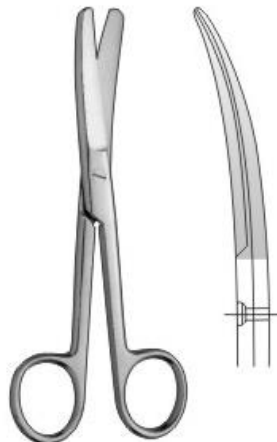

STANDARD CURVED
15-025-115 11.5 cm, 4 1/2"
15-026-130 13.0 cm, 5"
15-027-140 14.0 cm, 5 1/2"
15-028-150 15.0 cm, 6"
15-029-160 16.0 cm, 6 1/4"
15-030-175 17.5 cm, 7"
15-031-185 18.5 cm, 7 1/4"
15-032-200 20.0 cm, 8"
 B/B Cvd.

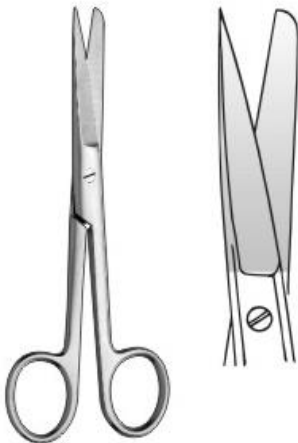

STANDARD STRAIGHT
15-033-115 11.5 cm, 4 1/2"
15-034-130 13.0 cm, 5"
15-035-140 14.0 cm, 5 1/2"
15-036-150 15.0 cm, 6"
15-037-160 16.0 cm, 6 1/4"
15-038-175 17.5 cm, 7"
15-039-185 18.5 cm, 7 1/4"
15-040-200 20.0 cm, 8"

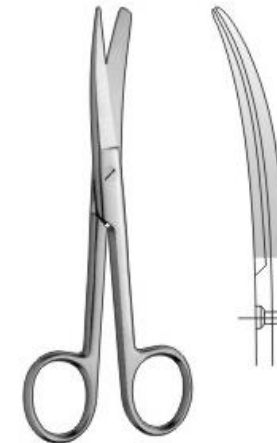

STANDARD CURVED
15-041-115 11.5 cm, 4 1/2"
15-042-130 13.0 cm, 5"
15-043-140 14.0 cm, 5 1/2"
15-044-150 15.0 cm, 6"
15-045-160 16.0 cm, 6 1/4"
15-046-175 17.5 cm, 7"
15-047-185 18.5 cm, 7 1/4"
15-048-200 20.0 cm, 8"

FLAT PATTERN

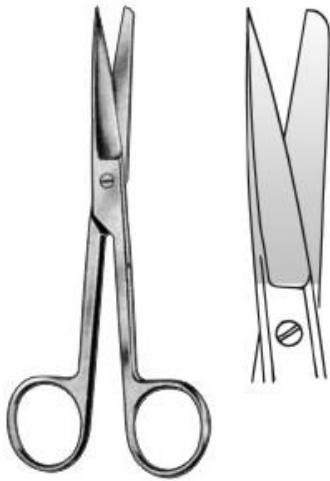

STANDARD STRAIGHT

15-049-115	11.5 cm, 4 1/2"
15-050-130	13.0 cm, 5"
15-051-140	14.0 cm, 5 1/2"
15-052-150	15.0 cm, 6"
15-053-160	16.0 cm, 6 1/4"
15-054-175	17.5 cm, 7"
15-055-185	18.5 cm, 7 1/4"
15-056-200	20.0 cm, 8"
S/B Str.	



STANDARD CURVED

15-057-115	11.5 cm, 4 1/2"
15-058-130	13.0 cm, 5"
15-059-140	14.0 cm, 5 1/2"
15-060-150	15.0 cm, 6"
15-061-165	16.0 cm, 6 1/4"
15-062-175	17.5 cm, 7"
15-063-185	18.5 cm, 7 1/4"
15-064-200	20.0 cm, 8"
S/B Cvd.	

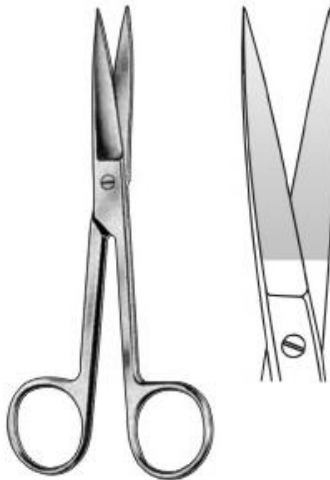

STANDARD STRAIGHT

15-065-115	11.5 cm, 4 1/2"
15-066-130	13.0 cm, 5"
15-067-140	14.0 cm, 5 1/2"
15-068-150	15.0 cm, 6"
15-069-160	16.0 cm, 6 1/4"
15-070-175	17.5 cm, 7"
15-071-185	18.5 cm, 7 1/4"
15-072-200	20.0 cm, 8"
S/S Str.	



STANDARD CURVED

15-073-115	11.5 cm, 4 1/2"
15-074-130	13.0 cm, 5"
15-075-140	14.0 cm, 5 1/2"
15-076-150	15.0 cm, 6"
15-077-160	16.0 cm, 6 1/4"
15-078-175	17.5 cm, 7"
15-079-185	18.5 cm, 7 1/4"
15-080-200	20.0 cm, 8"
S/S Cvd.	



STANDARD STRAIGHT

15-081-115	11.5 cm, 4 1/2"
15-082-130	13.0 cm, 5"
15-083-140	14.0 cm, 5 1/2"
15-084-150	15.0 cm, 6"
15-085-160	16.0 cm, 6 1/4"
15-086-175	17.5 cm, 7"
15-087-185	18.5 cm, 7 1/4"
15-088-200	20.0 cm, 8"
B/B Str.	



STANDARD CURVED

15-089-115	11.5 cm, 4 1/2"
15-090-130	13.0 cm, 5"
15-091-140	14.0 cm, 5 1/2"
15-092-150	15.0 cm, 6"
15-093-160	16.0 cm, 6 1/4"
15-094-175	17.5 cm, 7"
15-095-185	18.5 cm, 7 1/4"
15-096-200	20.0 cm, 8"
B/B Cvd.	

Operating, Dissecting Scissors

FINE PATTERN



GRAZIL STRAIGHT
 15-097-130 13.0 cm, 5"
 15-098-145 14.5 cm, 5 3/4"
 S/B Str.



GRAZIL CURVED
 15-099-130 13.0 cm, 5"
 15-100-145 14.5 cm, 5 3/4"
 S/B Cvd.



GRAZIL STRAIGHT
 15-101-130 13.0 cm, 5"
 15-102-145 14.5 cm, 5 3/4"
 S/S Str.



GRAZIL CURVED
 15-103-130 13.0 cm, 5"
 15-104-145 14.5 cm, 5 3/4"
 S/S Cvd.



GRAZIL STRAIGHT
 15-105-130 13.0 cm, 5"
 15-106-145 14.5 cm, 5 3/4"
 B/B Str.



GRAZIL CURVED
 15-107-130 13.0 cm, 5"
 15-108-145 14.5 cm, 5 3/4"
 B/B Cvd.



Dissecting & Gynecological Scissors



MAYO-STILLE
 15-121-150 15.0 cm, 6"
 15-122-170 17.0 cm, 6 3/4"
 Str.

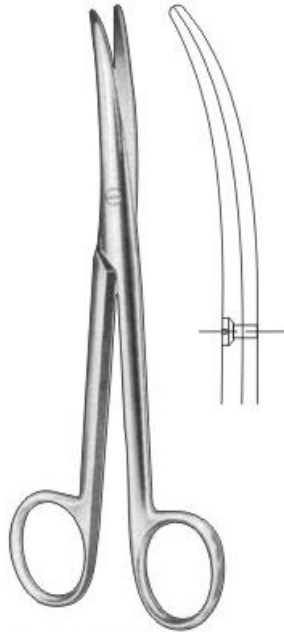

MAYO-STILLE
 15-123-150 15.0 cm, 6"
 15-124-170 17.0 cm, 6 3/4"
 Cvd.

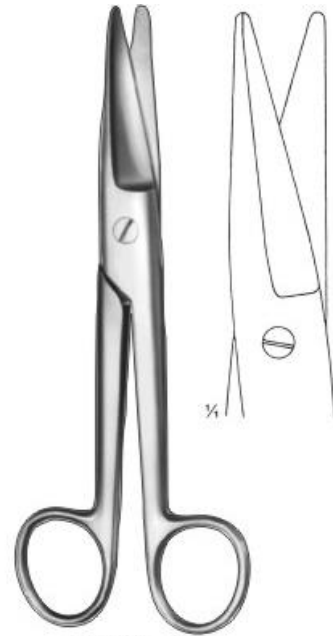

MAYO-NOBLE
 15-125-170
 17.0 cm, 6 3/4"
 Str.

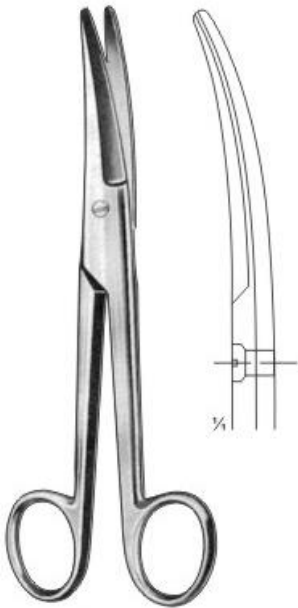

MAYO-NOBLE
 15-126-170
 17.0 cm, 6 3/4"
 Cvd.



MAYO Str.
 15-127-145 14.5 cm, 5 1/2"
 15-128-150 15.0 cm, 6"
 15-129-170 17.0 cm, 6 3/4"

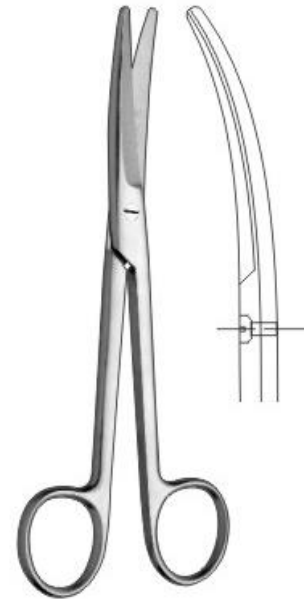

MAYO Cvd.
 15-130-145 14.5 cm, 5 1/2"
 15-131-150 15.0 cm, 6"
 15-132-170 17.0 cm, 6 3/4"

Operating, Dissecting scissors

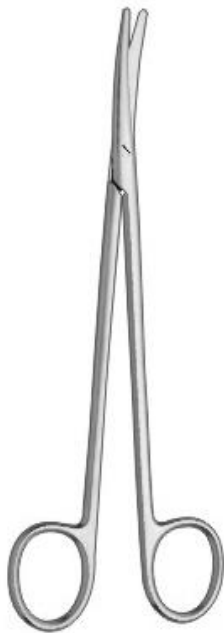

METZENBAUM
Blunt / Blunt

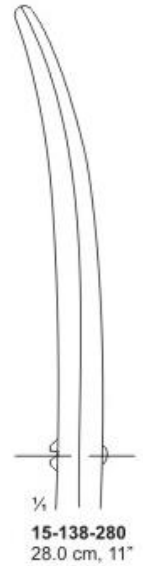

METZENBAUM
Blunt / Blunt

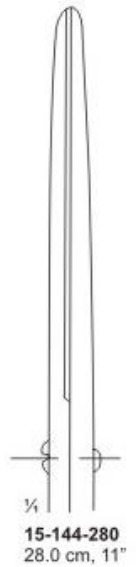
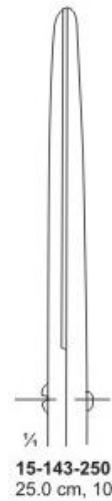

Dissecting Scissors



METZENBAUM
Blunt / Blunt



15-133-180
14.5 cm, 5 3/4"



15-134-180
18.0 cm, 7"



15-135-200
20.0 cm, 8"



15-136-230
23.0 cm, 9"



15-137-250
25.0 cm, 10"



15-138-280
28.0 cm, 11"



METZENBAUM
Blunt / Blunt



15-139-145
14.5 cm, 5 3/4"



15-140-180
18.0 cm, 7"



15-141-200
20.0 cm, 8"

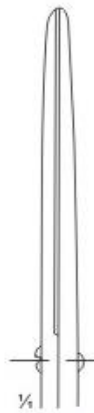

15-142-230
23.0 cm, 9"



15-143-250
25.0 cm, 10"

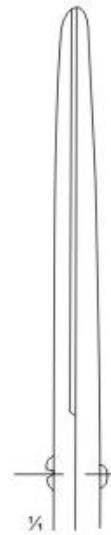

15-144-280
28.0 cm, 11"

Face-life, Dissecting, Nasal Scissors



THOREK-FELDMAN
Gall Bladder Scissor
15-179-180
18.0 cm, 7"

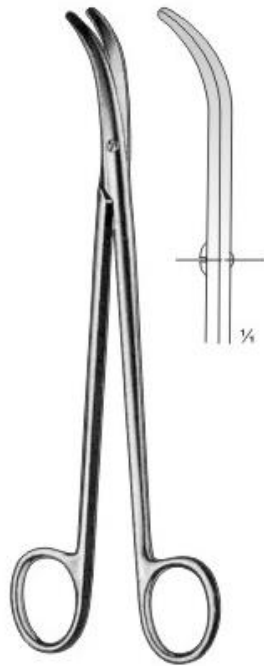

THOREK
15-180-190
19.0 cm, 7 1/2"



LEXER-BABY
15-181-100
10.0 cm, 4"

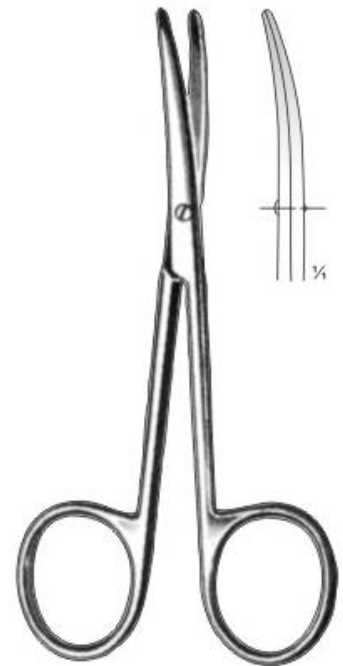

LEXER-BABY
15-182-100
10.0 cm, 4"

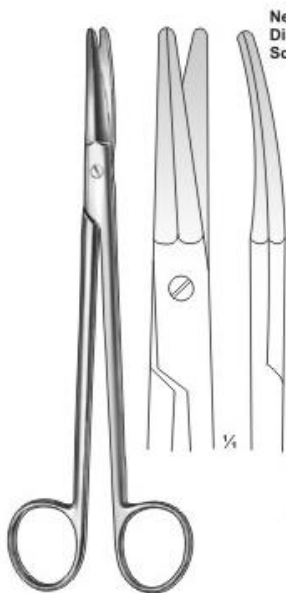

**KAYE FACE-LIFT
SCISSORS**
15-183-185
18.5 cm, 7 1/4"

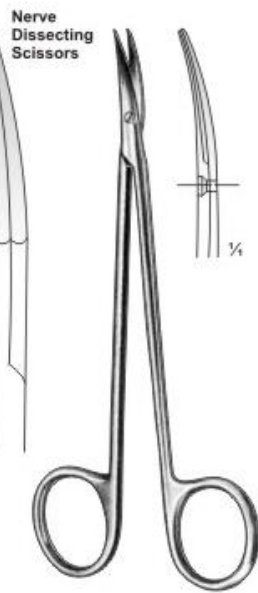

Straight
15-184-150
15.0 cm, 6"



Curved
15-185-150
15.0 cm, 6"



LEXER
15-186-160
16.0 cm, 6 1/4"

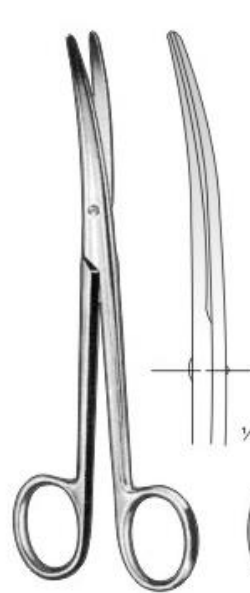

LEXER
15-187-160
16.0 cm, 6 1/4"

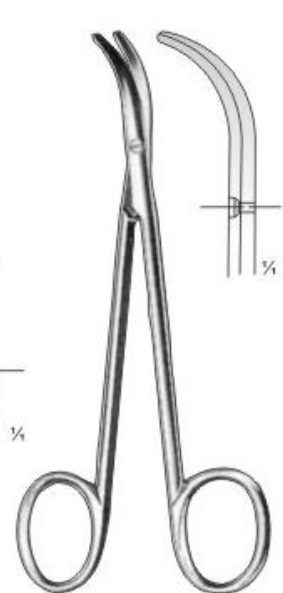

FOMON
15-188-135
13.5 cm, 5 1/4"



Plastic

KILNER
15-189-120 12.0 cm, 4 3/4"
15-190-150 15.0 cm, 6"
15-191-180 18.0 cm, 7"
15-192-200 20.0 cm, 8"
 Str.

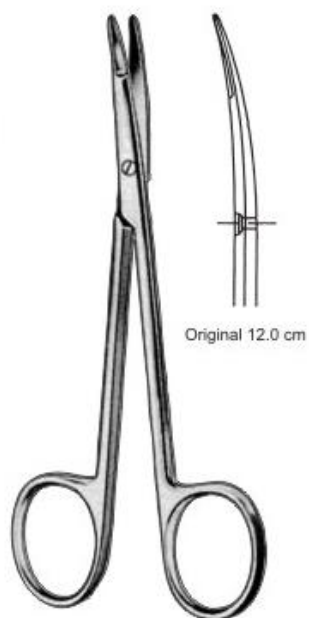

Original 12.0 cm

KILNER
15-193-120 12.0 cm, 4 3/4"
15-194-150 15.0 cm, 6"
15-195-180 18.0 cm, 7"
15-196-200 20.0 cm, 8"
 Cvd.



REYNOLDS
15-197-150 15.0 cm, 6"
15-198-180 18.0 cm, 7"
 Str.

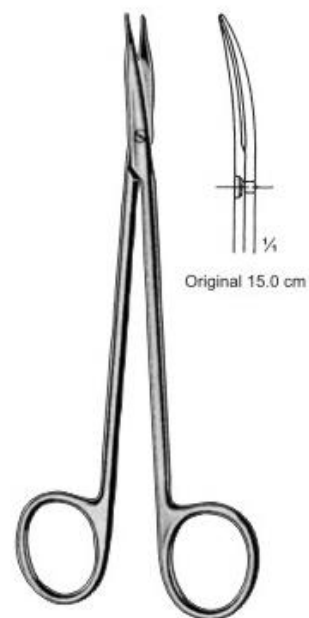

Original 15.0 cm

REYNOLDS
15-199-150 15.0 cm, 6"
15-200-180 18.0 cm, 7"
 Cvd.



SANVENERO
15-201-140
 14.0 cm, 5 1/2"
 Str.

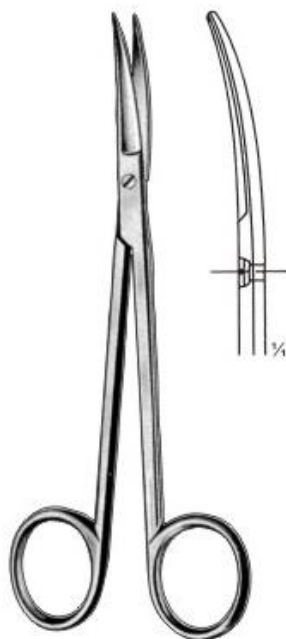

SANVENERO
15-202-140
 14.0 cm, 5 1/2"
 Cvd.



JOSEPH
15-203-140
 14.0 cm, 5 1/2"
 Str.

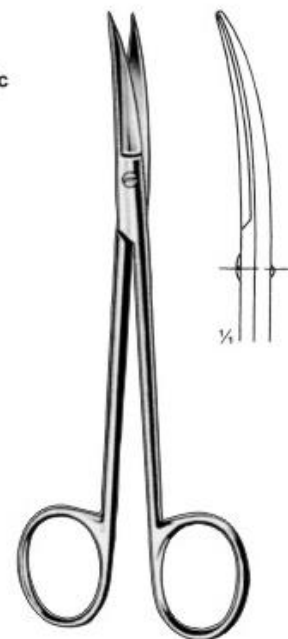

Plastic

JOSEPH
15-204-140
 14.0 cm, 5 1/2"
 Cvd.



KELLY
15-205-160 16.0 cm, 6 ¼"
15-206-180 18.0 cm, 7"
 Str.

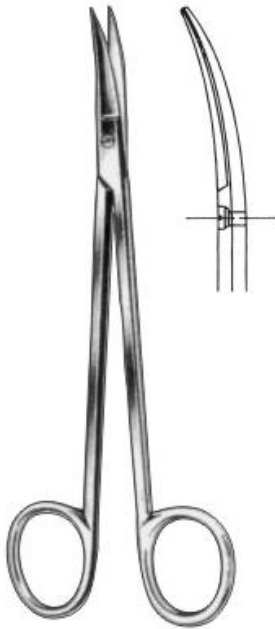

KELLY
15-207-160 16.0 cm, 6 ¼"
15-208-180 18.0 cm, 7"
 Cvd.



VEZIEN
15-209-180
 18.0 cm, 7"

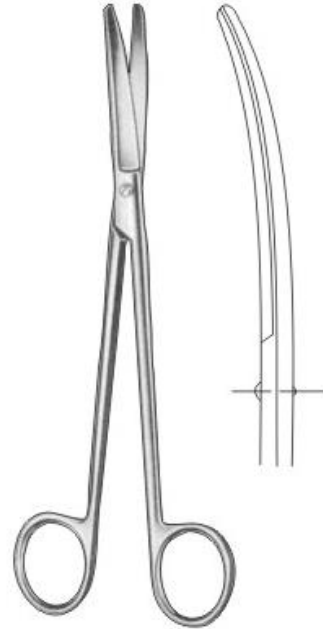

WETHEIM
15-210-145 14.5 cm, 5 ¾"
15-211-195 19.5 cm, 7 ¾"
15-212-225 22.5 cm, 8 ¾"



DOYEN
15-213-160
 16.0 cm, 6 ¼"
 S/B, Str.



DOYEN
15-214-160
 16.0 cm, 6 ¼"
 B/B, Str.



DOYEN
15-215-160
 16.0 cm, 6 ¼"
 B/B, Cvd.

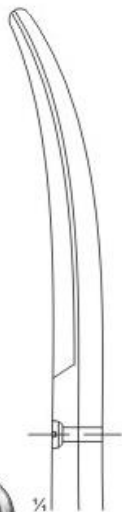

DOYEN
15-216-175
 17.5 cm, 6 ¾"
 B/B, Str.



DOYEN
15-217-175
 17.5 cm, 6 ¾"
 B/B, Cvd.



Dissecting & Gynecological Scissors



DUBOIS
15-218-270
27.0 cm, 10 3/4"

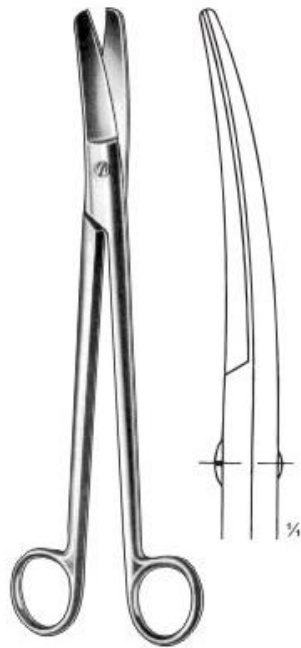

DUBOIS
15-219-270
27.0 cm, 10 3/4"

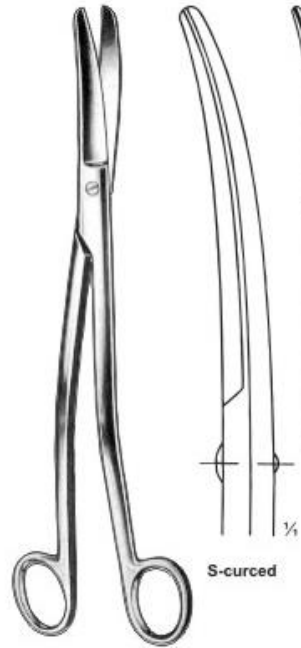

SIEBOLD
15-220-240
24.0 cm, 9 1/2"



CARDINALE
15-221-280
28.0 cm, 11"



SIMS
15-222-200 20.0 cm, 8"
15-223-230 23.0 cm, 9"
Straight, B/B



15-224-200
20.0 cm, 8"
15-225-230
23.0 cm, 9"
S/B



15-226-200
20.0 cm, 8"
15-227-230
23.0 cm, 9"
S/S

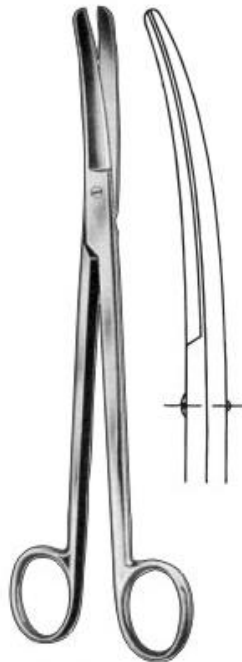

SIMS
15-228-200 20.0 cm, 8"
15-229-230 23.0 cm, 9"
Curved, B/B



15-230-200
20.0 cm, 8"
15-231-230
23.0 cm, 9"
S/B



15-232-200
20.0 cm, 8"
15-233-230
23.0 cm, 9"
S/S

Iris, Tendon Scissors



15-234-100
10 cm, 4"
Large Rings, Straight
Sharp / Sharp
15-235-100
10 cm, 4"
Large Rings, Curved
Sharp / Sharp

IRIS

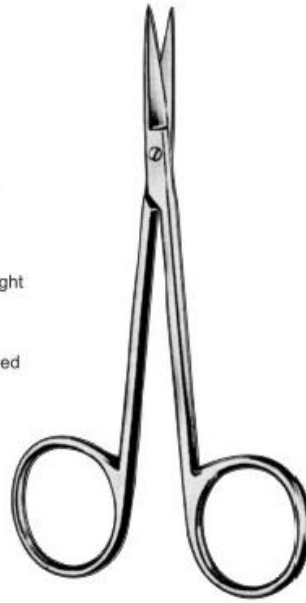

IRIS SCISSORS

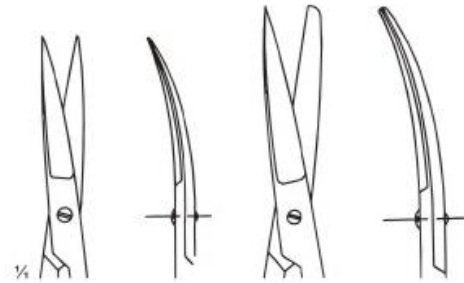

Item	Description	Tip	
15-236-090	09 cm, 3 1/2"	Straight	Sharp/Sharp
15-237-105	10.5 cm, 4 1/4"	Straight	Sharp/Sharp
15-238-115	11.5 cm, 4 1/2"	Straight	Sharp/Sharp
15-239-120	12.0 cm, 4 3/4"	Straight	Sharp/Sharp
15-240-090	09 cm, 3 1/2"	Curved	Sharp/Blunt
15-241-105	10.5 cm, 4 1/4"	Curved	Sharp/Blunt
15-242-115	11.5 cm, 4 1/2"	Curved	Sharp/Blunt
15-243-120	12.0 cm, 4 3/4"	Curved	Sharp/Blunt



15-244-115
11.5 cm, 4 1/2"
Straight,
sharp/sharp

KILLNER



15-245-115
11.5 cm, 4 1/2"
Curved,
sharp/sharp

LITTLER



15-246-140
14 cm, 5 1/2"
Curved,
sharp/sharp



15-247-115
11.5 cm, 4 1/2"
Curved, blunt/blunt
15-248-115
11.5 cm, 4 1/2"
Straight, blunt/blunt

STRABISMUS



IRIS ANGULAR
15-249-114
11.4 cm, 4 ½"



IRIS
15-250-115
11.5 cm, 4 ½"



**POTTS-REYNOLDS
TENOTOMY**
15-251-120
12.0 cm, 4 ¾"
Curved



POTTS TENOTOMY
15-252-152 15.2 cm, 6"
15-253-178 17.8 cm, 7"
15-254-203 20.3 cm, 8"

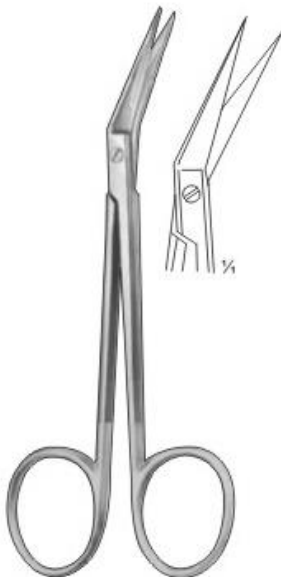

IRIS ANGULAR
15-255-110
11cm 4 ¼"



KNAPP IRIS
15-256-102 Straight.
15-257-102 Curved
10.2 cm, 4"

Blades length
3.5 cm



WILMER IRIS
15-258-089
8.9 cm, 3 ½"

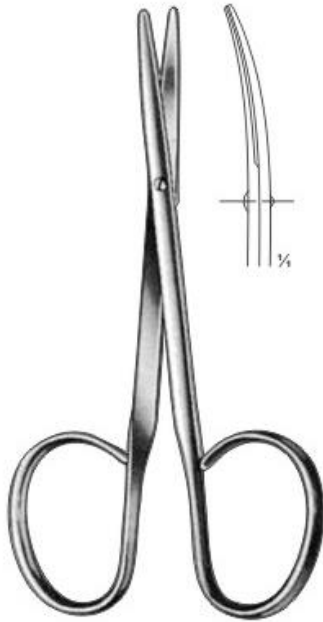

15-259-100
10.0 cm, 4"
Straight



15-260-100
10.0 cm, 4"
Curved

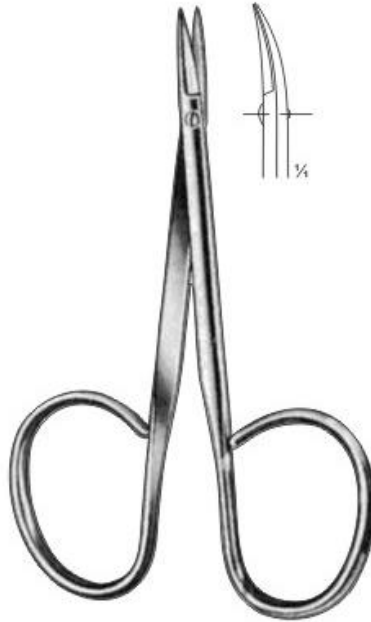

15-261-095
9.5 cm, 3 3/4"
Straight



15-262-095
9.5 cm, 3 3/4"
Curved

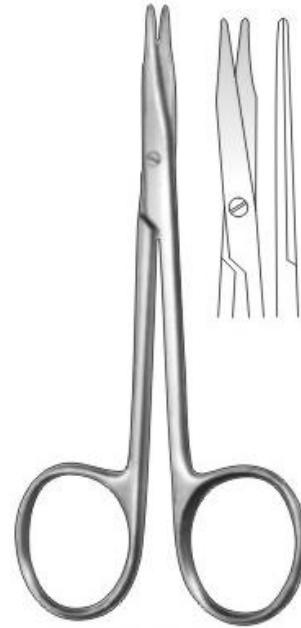

TENOTOMY-STEVENS
15-263-110 Straight
15-264-110 Curved
11 cm, 4 1/4"

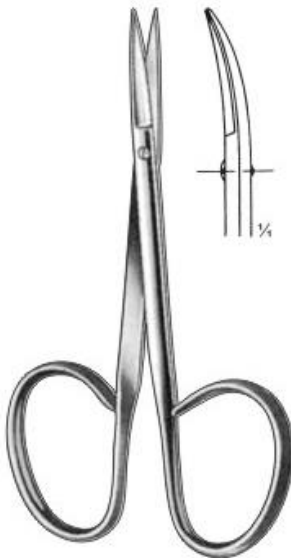
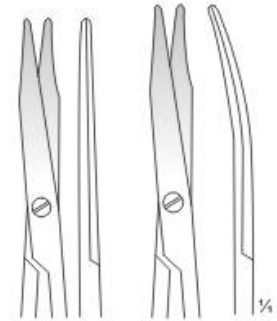

15-265-100
10.0 cm, 4"
Straight



15-266-100
10.0 cm, 4"
Curved



15-267-100
10.0 cm, 4"
Straight



15-268-100
10.0 cm, 4"
Curved

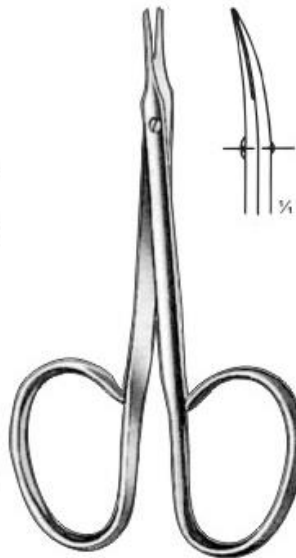

TENOTOMY
15-269-095
9.5 cm, 3 3/4"
Curved-Ribbon
Handles blunt/blunt



15-270-095
9.5 cm, 3 3/4"
Straight

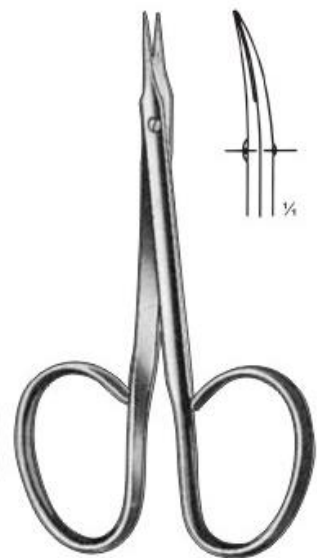

15-271-095
9.5 cm, 3 3/4"
Curved

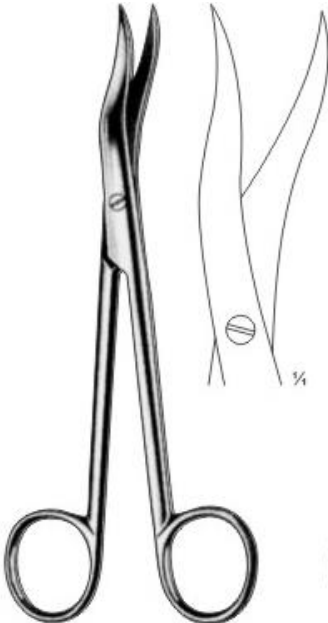

15-272-160
16.0 cm, 6 1/4"

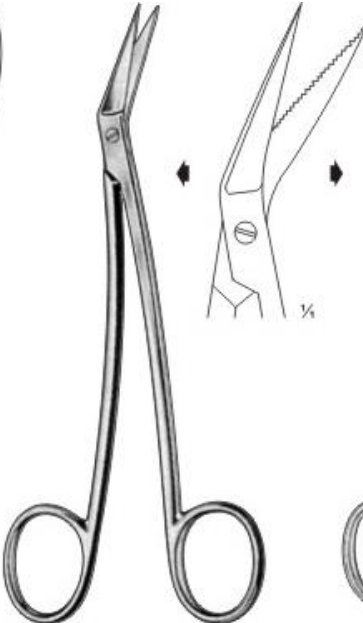

LOCKLIN
15-273-165
16.5 cm, 6 1/2"



LOCKLIN
15-274-165
16.5 cm, 6 1/2"

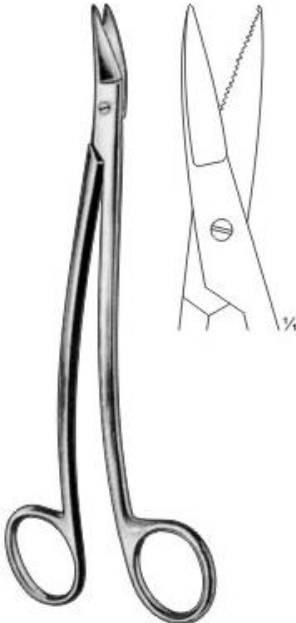

DEAN-DELICATE
15-275-170
17.0 cm, 6 3/4"

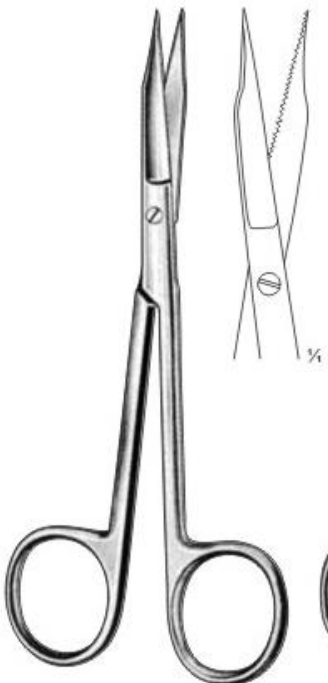

GOLDMAN-FOX
15-276-130
13.0 cm, 5"



GOLDMAN-FOX
15-277-130
13.0 cm, 5"

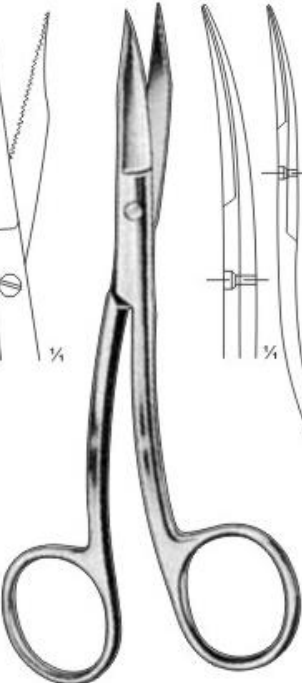

GOLDMAN-FOX (Spezial)
15-278-130
13.0 cm, 5"

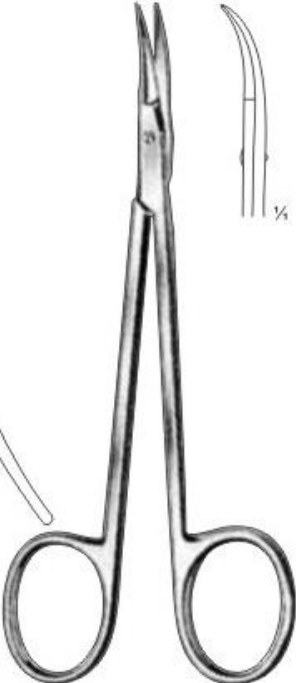

15-279-115
11.5 cm, 4 1/2"



15-280-190
19.0 cm, 7 1/2"

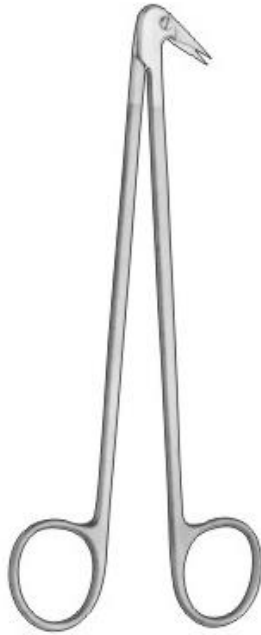

**COOLEY REVERSE
Cut Scissors**
15-281-171
angled 120°
17.1 cm, 6 3/4"

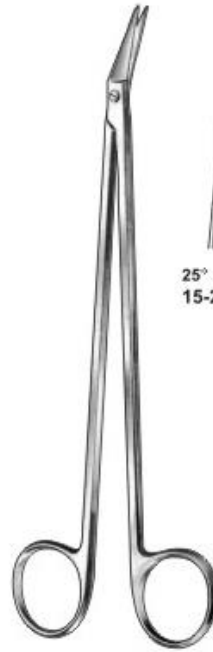

POTTS-SMITH
19.0 cm, 7 1/2"



25°
15-282-190



45°
15-283-190



60°
15-284-190

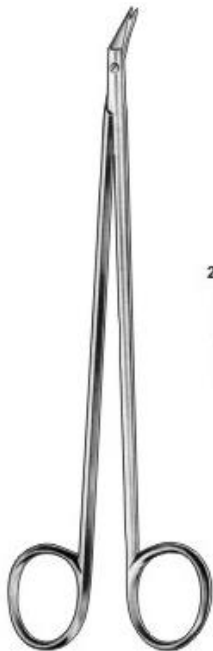

HEGEMANN-DIETRICH



25°
15-285-160
16.0 cm, 6 1/4"
15-286-190
19.0 cm, 7 1/2"



45°
15-287-160
16.0 cm, 6 1/4"
15-288-190
19.0 cm, 7 1/2"



60°
15-289-160
16.0 cm, 6 1/4"
15-290-190
19.0 cm, 7 1/2"



90°
15-291-160
16.0 cm, 6 1/4"
15-292-190
19.0 cm, 7 1/2"



125°
15-293-160
16.0 cm, 6 1/4"
15-294-190
19.0 cm, 7 1/2"



POTTS-DE MARTEL
15-295-210
 21.0 cm, 8 1/4"



MILLS
15-296-210
 21.0 cm, 8 1/4"



FULTON
15-297-170
 17.0 cm, 6 3/4"



POTTS-SMITH
15-298-197
 19.7 cm, 8"
 angled on flat 50°



POTTS-SMITH SCISSORS
15-299-133
 Short.
 Angled 45°
 13.3 cm, 5 1/4"

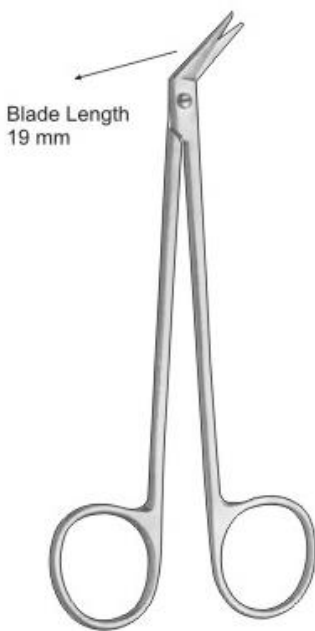

POTTS-SMITH SCISSORS
15-300-146
 short blades
 angled 45°
 14.6 cm, 5 3/4"



POTTS-SMITH
15-301-191 19.1 cm, 7 1/2" angled 25°
15-302-133 13.3 cm, 5 1/4" angled 45°
15-303-191 19.1 cm, 7 1/2" angled 45°
15-304-191 19.1 cm, 7 1/2" angled 60°
15-305-191 19.1 cm, 7 1/2" angled 90°



DE BAKEY



15-306-160	16.0 cm, 6 1/4"
15-307-190	19.0 cm, 7 1/2"
15-308-230	23.0 cm, 9"
15-309-280	28.0 cm, 11"

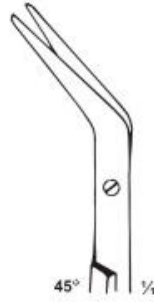

15-310-160	16.0 cm, 6 1/4"
15-311-190	19.0 cm, 7 1/2"
15-312-230	23.0 cm, 9"
15-313-280	28.0 cm, 11"

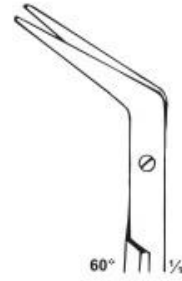

15-314-160	16.0 cm, 6 1/4"
15-315-190	19.0 cm, 7 1/2"
15-316-230	23.0 cm, 9"
15-317-280	28.0 cm, 11"

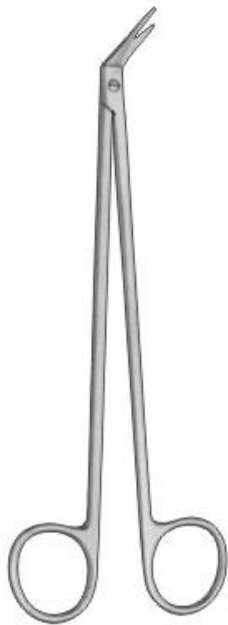

COOLEY
 angled 45°
 18.4 cm, 7 1/2"

15-318-184	1 mm probe point on tip.
15-319-184	1.5 mm probe point on tip.



O'BRIEN
15-320-090
 9.0 cm, 3 1/2"

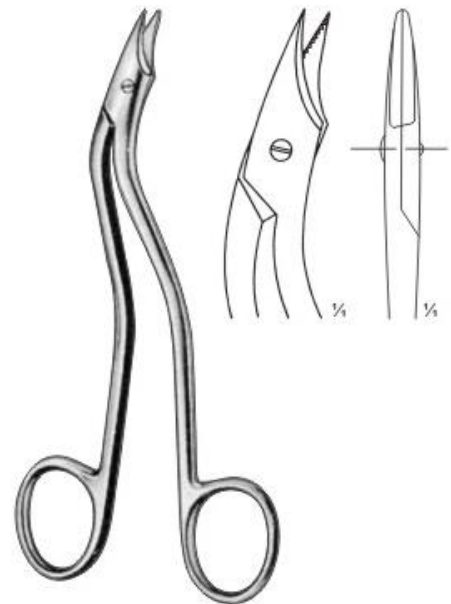

HEATH
15-321-150
 15.0 cm, 6"

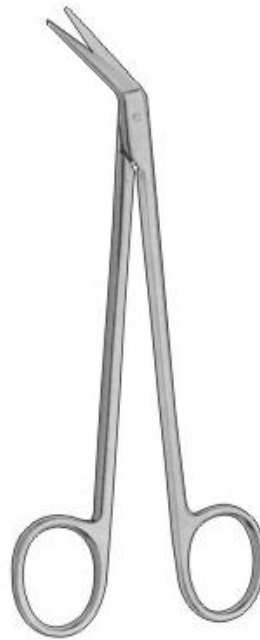

LITWIN ANGLED
15-322-184
 18.4 cm, 7 1/4"
 Angled 45°

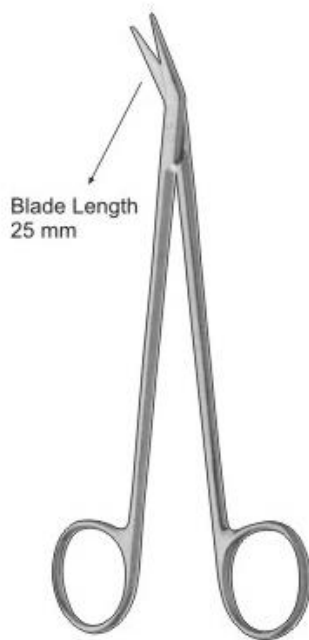

Blade Length
25 mm

DEBAKEY-POTTS
15-323-165 angled 20°
15-324-165 angled 45°
15-325-165 angled 60°
 16.5 cm, 6 1/2"

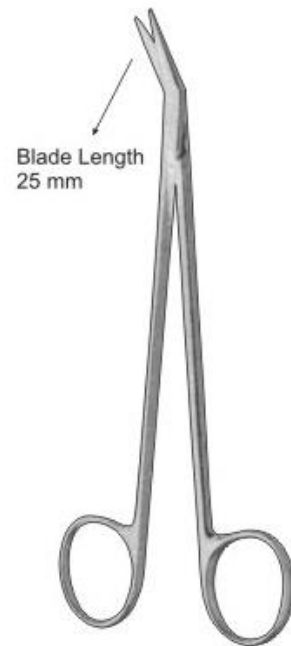

Blade Length
25 mm

DEBAKEY VASCULAR
15-326-229 angled 25°
15-327-229 angled 45°
15-328-229 angled 60°
15-329-229 angled 45°
 22.9 cm, 9"

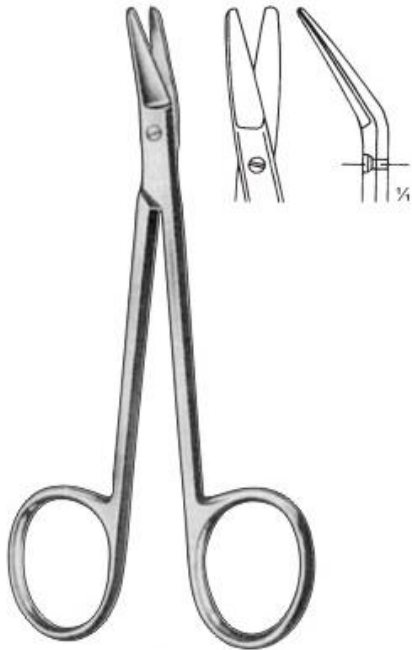

15-330-105
10.5 cm, 4"

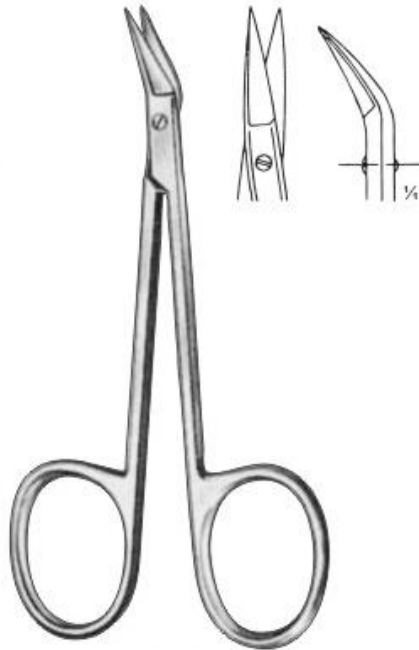

15-331-100
10.0 cm, 4"

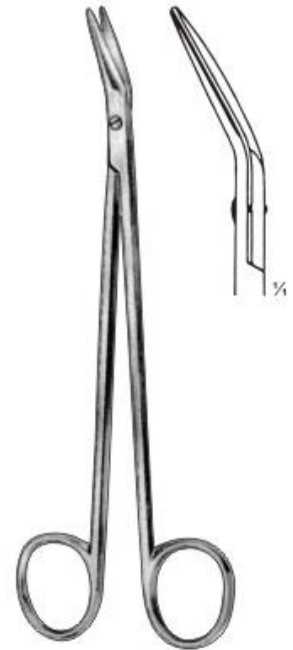

CLASSON
15-332-170
17.0 cm, 4"

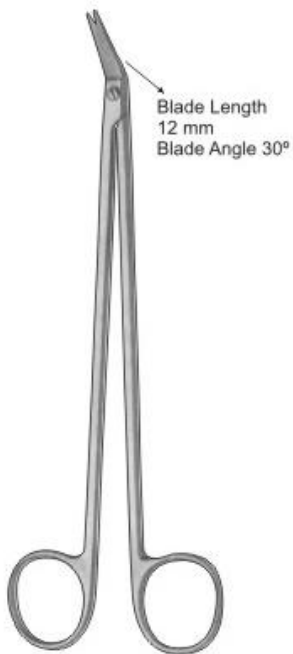

COOLEY ARTERIOTOMY
15-333-184 18.4 cm, 7 1/4"
15-334-229 22.9 cm, 9"
15-335-273 27.3 cm, 11"



SWEET ESOPHAGEAL
15-336-216
21.6 cm, 8 1/2"

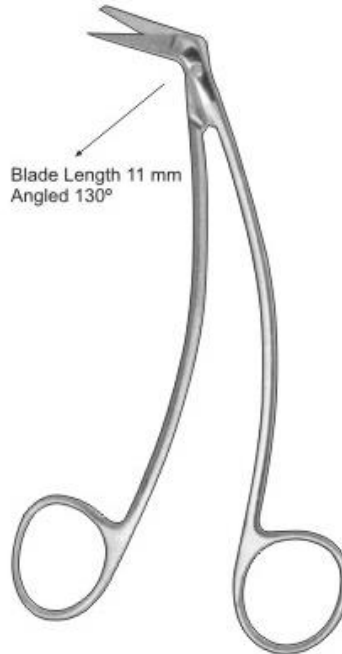

FAVALORO CORONARY
15-337-171
17.1 cm, 6 3/4"



15-338-105
10.5 cm, 4"
Angled 90°



COOLEY CARDIOVASCULAR
 15-339-191 19.1 cm, 7 1/2"
 15-340-229 22.9 cm, 9"
 Curved

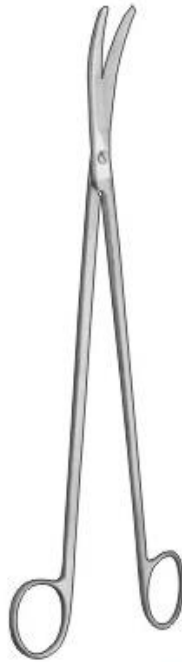

CRAFORD LOBECTOMY
 15-341-305
 30.5 cm, 12"
 curved



NELSON LUNG DISSECTING
 15-342-229 Straight
 15-343-229 Curved
 22.9 cm, 9"



FINOCHIETTO
 15-344-270
 27.0 cm, 10 1/2"



RESANO
 15-345-250
 25.0 cm, 10"

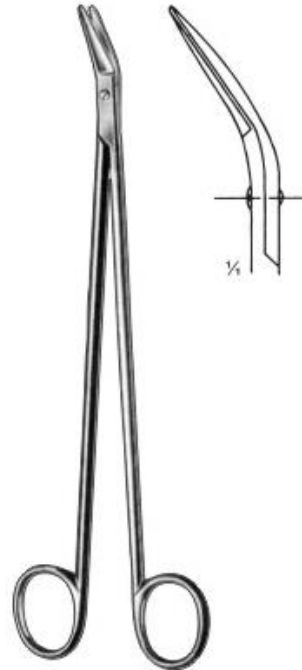

POTTS-SMITH
 15-346-195
 19.5 cm, 7 3/4"

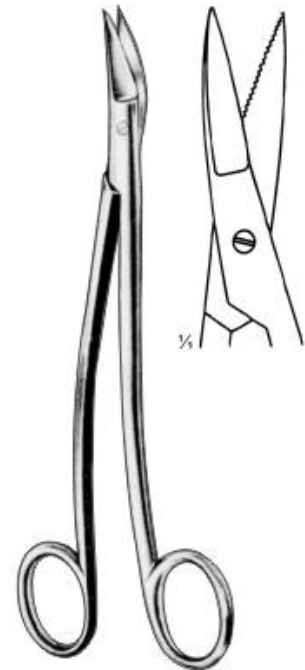

ENT-DEAN
 15-347-170
 17 cm, 6 3/4"
 Serrated

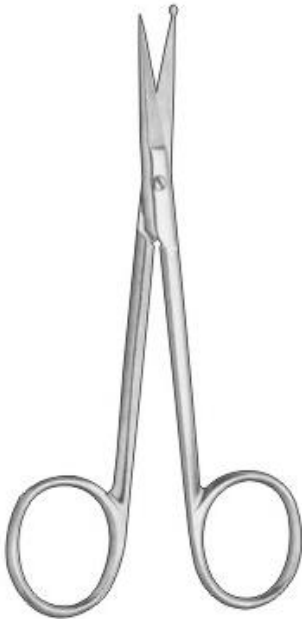

CARDIOVASCULAR
15-348-121
 12.1 cm, 4 3/4"
 curved

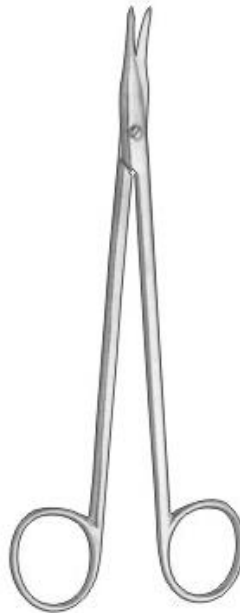

MORSE SCISSORS
15-349-178
 17.8 cm, 7"
 curved



LITWAK GENERAL UTILITY
15-350-117
 11.7 cm, 4 3/4"



MAYO-HARRINGTON DISSECTING
15-351-229 22.9 cm, 9" Straight.
15-352-279 27.9 cm, 11" Straight.
15-353-229 22.9 cm, 9" Curved.
15-354-279 27.9 cm, 11" Curved.



TOENIS DISSECTING
15-355-184 Straight
 18.4 cm, 7 1/4"
15-356-181 Curved.
 18.1 cm, 7"
 Delicate



Blade Length
2.9 cm

DEMARTEL VASCULAR
15-357-171 17.1 cm, 6 3/4" Curved.
15-358-197 19.7 cm, 8" Straight.
15-359-171 17.1 cm, 6 3/4" Straight.



DEBAKEY ENDARTERECTOMY
15-360-178
 17.8 cm, 7"
 curved



STRULLY
15-361-220
22.0 cm, 8 3/4"



STRULLY
15-362-220
22.0 cm, 8 3/4"



DANDY
15-363-170
17.0 cm, 6 3/4"

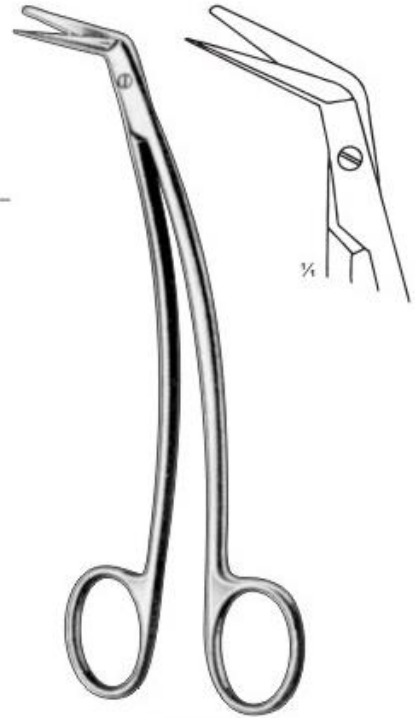

FAVALORO
15-364-150
15.0 cm, 6"



15-365-115
11.5 cm, 4 1/2"



15-366-145
14.5 cm, 5 3/4"



15-367-145
14.5 cm, 5 3/4"

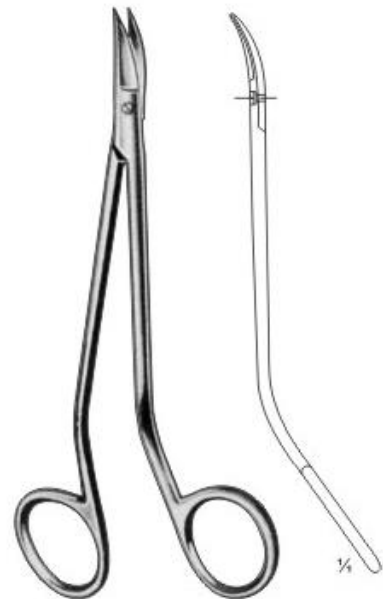

NEUMANN
15-368-125
12.5 cm, 5"

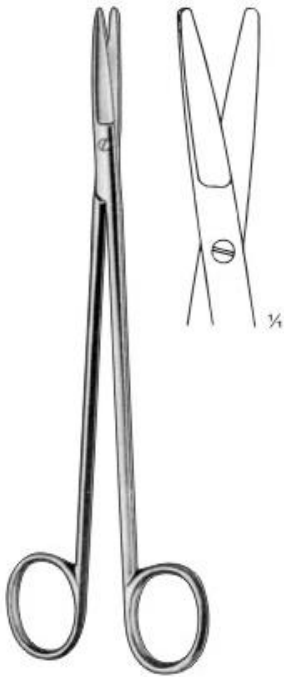

TOENNIS
15-369-180
18.0 cm, 7"



TOENNIS
15-370-180
18.0 cm, 7"



QUINBY
15-371-120
12.0 cm, 4 3/4"



QUINBY
15-372-120
12.0 cm, 4 3/4"



DE BAKEY
15-373-155
15.5 cm, 6"

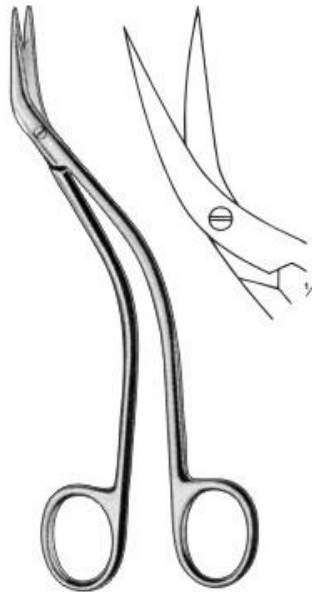

DE BAKEY
15-374-155
15.5 cm, 6"



SCHMIEDEN-TAYLOR
15-375-145 14.5 cm, 5 3/4"
15-376-175 17.5 cm, 6 3/4"

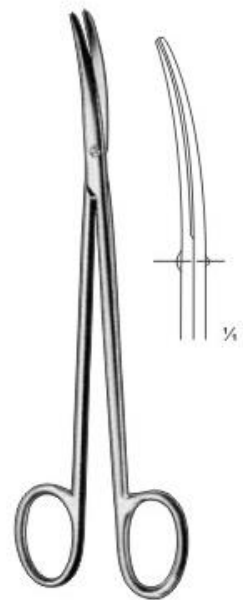

TOENNIS-ADSON
15-377-175
17.5 cm, 6 3/4"

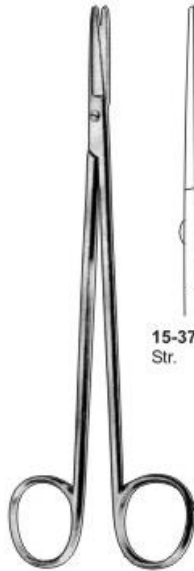

15-378-170
Str.

CHURCH
17.0 cm, 6 3/4"



15-379-170
Cvd.

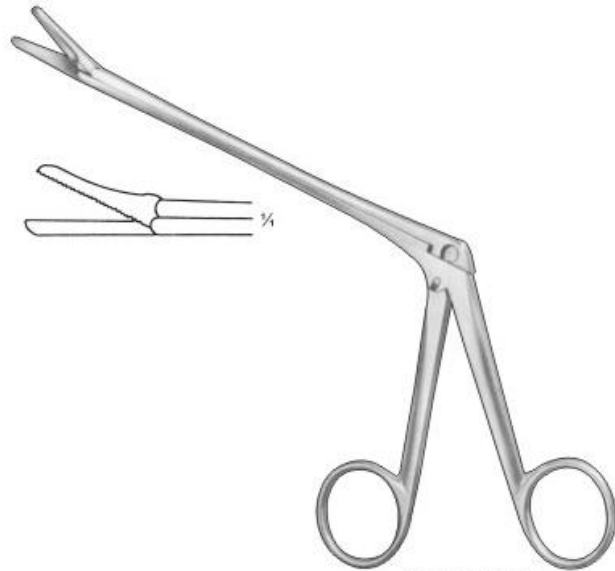

OLIVECRONA
15-380-230
23.0 cm, 9"



KLINKENBERGH-LOTH
15-381-230
23.0 cm, 9"

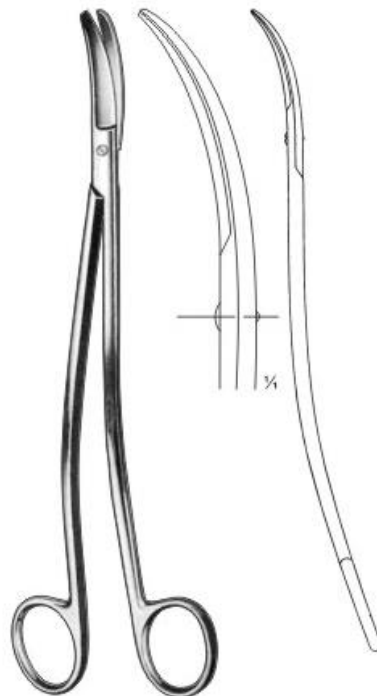

SATINSKY
15-382-245
24.5 cm, 9 3/4"

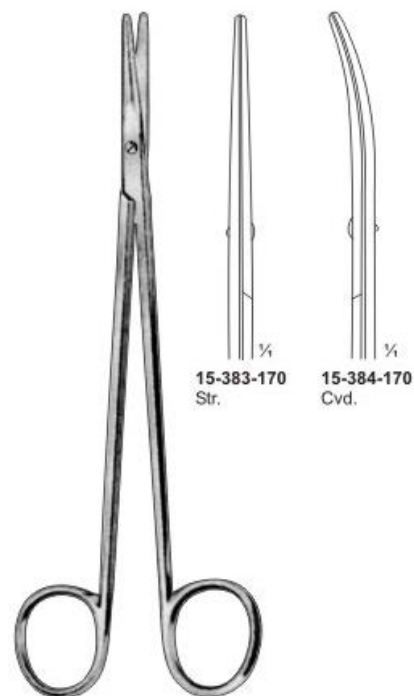

LINCOLN
17.0 cm, 6 3/4"

15-383-170
Str.

15-384-170
Cvd.

Vascular, Enterotomy scissors



ENTEROTOMY
15-385-210
21.0 cm, 8 1/4"



ENTEROTOMY
15-386-210
21.0 cm, 8 1/4"



ENTEROTOMY
15-387-210
21.0 cm, 8 1/4"



DISSECTING
15-388-110 11.5 cm, 4 1/4"
15-389-130 13.0 cm, 5"
15-390-140 14.0 cm, 5 1/2"



DISSECTING
15-391-110 11.5 cm, 4 1/4"
15-392-130 13.0 cm, 5"
15-393-140 14.0 cm, 5 1/2"

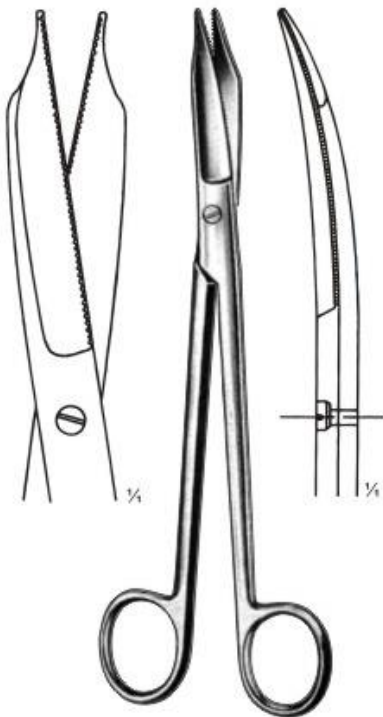

MARTIN-CARTILAGE
15-394-200
20.0 cm, 8"



MC INDOE
15-395-190
19.0 cm, 7 1/2"

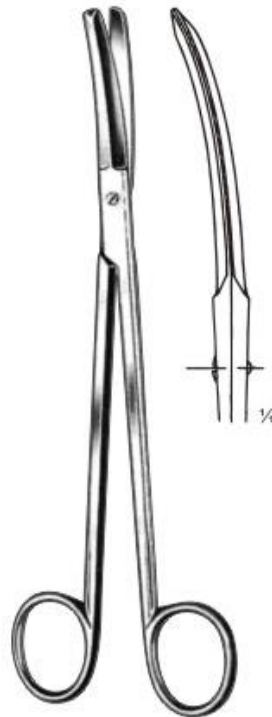

POTTS-SMITH
15-396-190
19.0 cm, 7 1/2"

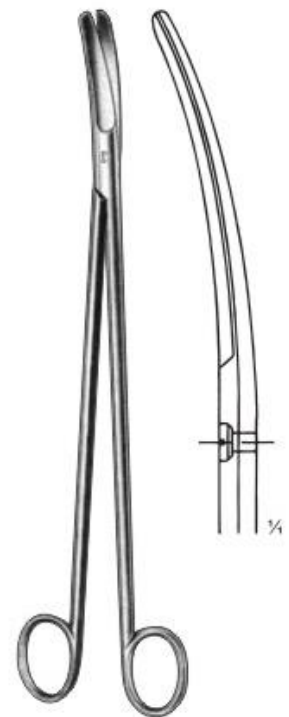

CRAFOORD
15-397-300
30.0 cm, 11 3/4"

Tonsil, Nasal Scissors

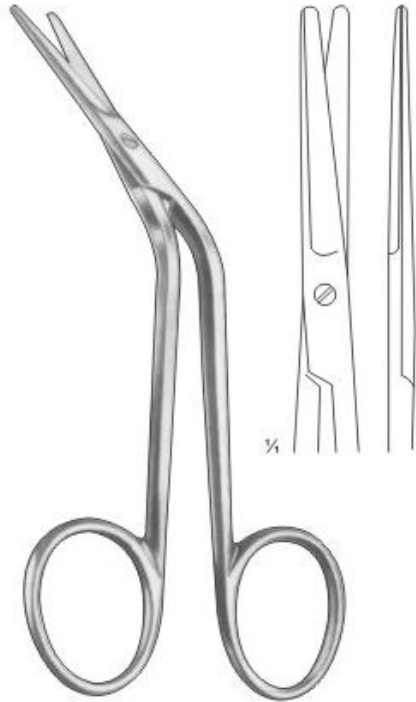

COTTLE
15-398-160
16 cm 6 1/4"

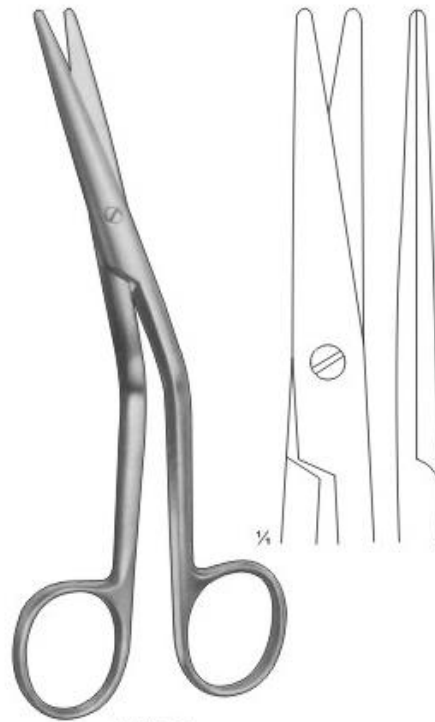

FOMON
15-399-145
14.5 cm 5 1/2"



HEYMANN
15-400-180
18 cm, 7"



HEYMANN
15-401-195
19.5 cm, 7 1/2"



KNIGHT
15-402-180
18.0 cm, 7"



**WAGNER
GUM SCISSORS**
12.0 cm, 4 3/4"

Straight



15-403-120
B/B



15-404-120
S/B



15-405-120
S/S

Curved



15-406-120
B/B



15-407-120
S/B



15-408-120
S/S



BROPHY (SULLIVAN)
15-409-140
14.0 cm, 5 1/2"
Str.

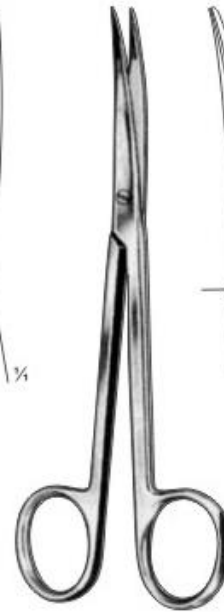

BROPHY (SULLIVAN)
15-410-140
14.0 cm, 5 1/2"
Cvd.



GOOD
15-411-190
19.0 cm, 7 1/2"



PRINCE
15-412-175
17.5 cm, 6 3/4"

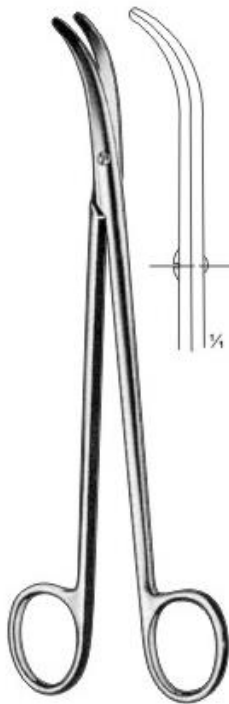

HALLE
15-413-190
19.0 cm, 7 1/2"

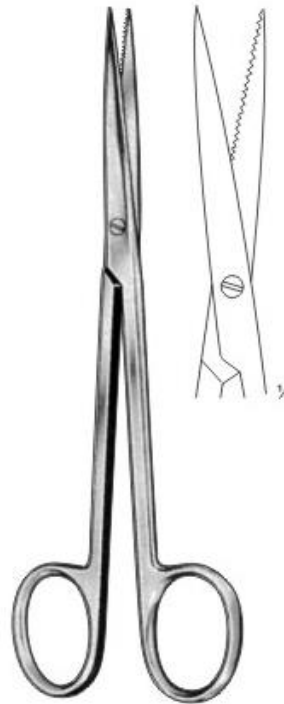

SULLIVAN
15-414-145
14.5 cm, 5 3/4"



SULLIVAN
15-415-145
14.5 cm, 5 3/4"



WALTON
15-416-100
10.0 cm, 4"

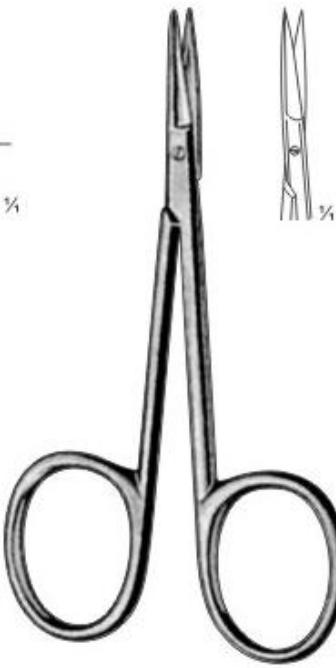

MOD. BONN
15-417-080
8.0 cm, 3"

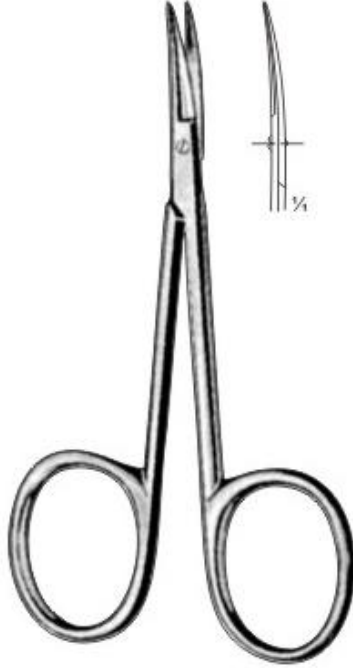

MOD. BONN
15-418-080
8.0 cm, 3"



LANDOLT
15-419-125
12.5 cm, 5"



OPERATING FINE
15-420-120 Straight
15-421-120 Curved
12 cm, 4 1/4"

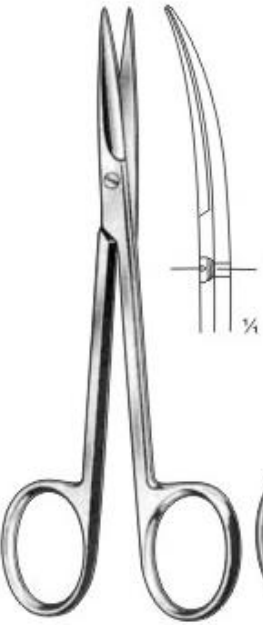

15-422-140
14.0 cm, 5 1/2"



15-423-105
10.5 cm, 4"
15-424-115
11.5 cm, 4 1/2"



15-425-105
10.5 cm, 4"
15-426-115
11.5 cm, 4 1/2"



15-427-115
11.5 cm, 4 1/2"

Gum & Stitch Scissors

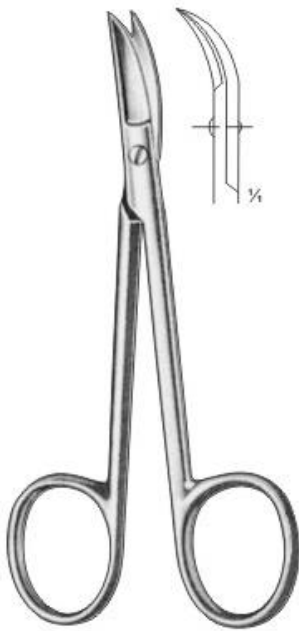

CHADWICK
15-428-110
11 cm, 4 1/4"



HARVEY
15-429-125
12.5 cm, 5"
Saw Edge



ROUND CUT
15-430-235
23.5 cm, 9"

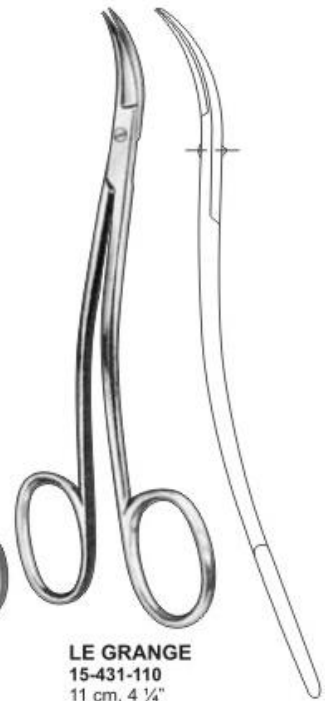

LE GRANGE
15-431-110
11 cm, 4 1/4"

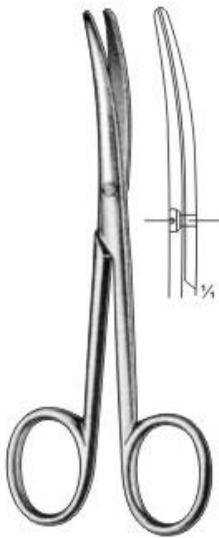

LANDOLT
15-432-125
12.5 cm, 5"

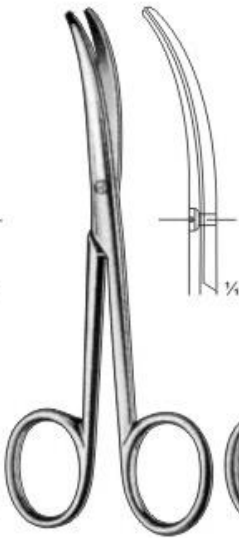

LANDOLT
15-433-125
12.5 cm, 5"

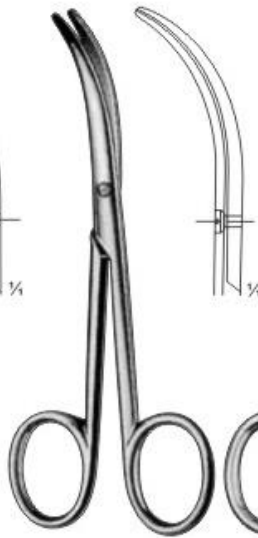

LANDOLT
15-434-125
12.5 cm, 5"

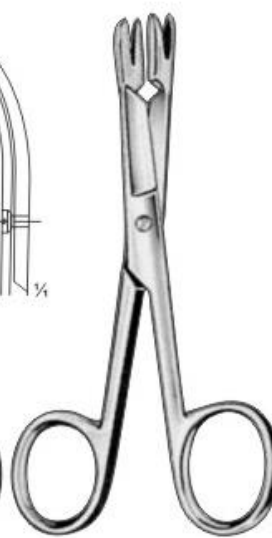

SCHOEMAKER-LOTH
15-435-125
12.5 cm, 5"



EISELSBERG
15-436-110
11.0 cm, 4 1/4"



15-437-120
12.0 cm, 4 3/4"



NORTHBENT
15-438-125
12.5 cm, 5"



LITTAUER
15-439-140
14 cm, 5 1/2"



BUCK
15-440-145 14.5 cm, 5 3/4"
15-441-180 18.0 cm, 7"

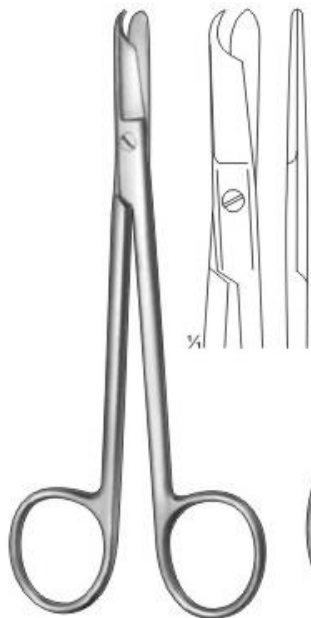

SPENCER
15-442-090
9 cm, 3 1/2"

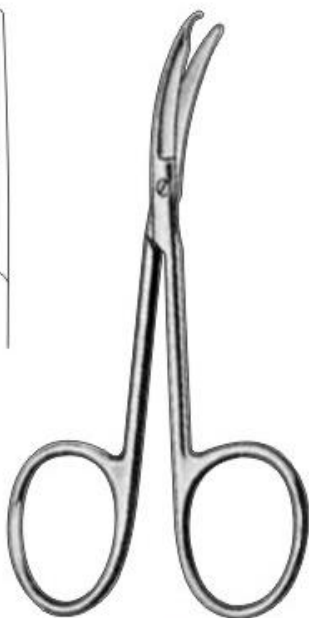

SHORTBENT
15-443-090
9 cm, 3 1/2"



SPENCER / DELICATE
15-444-110
11 cm, 4 1/2"



15-445-115
11.5 cm, 4 3/4"

Wire cutting Scissors



15-446-090
9.0 cm, 3 1/2"



15-447-090
9.0 cm, 3 1/2"



15-448-110
11.0 cm, 4 1/4"



15-449-110
11.0 cm, 4 1/4"



BEEBEE
15-450-120
12.0 cm, 4 3/4"

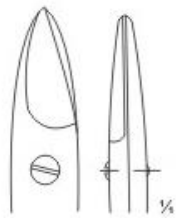

Saw Edge



BEEBEE
15-451-120
12.0 cm, 4 3/4"

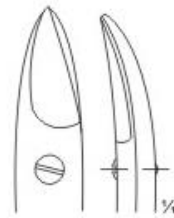

Saw Edge



BEEBEE
15-452-105
10.5 cm, 4"



SMITH
15-453-175
17.5 cm, 6 ¾"



BEEBEE
10.5 cm, 4"
Straight

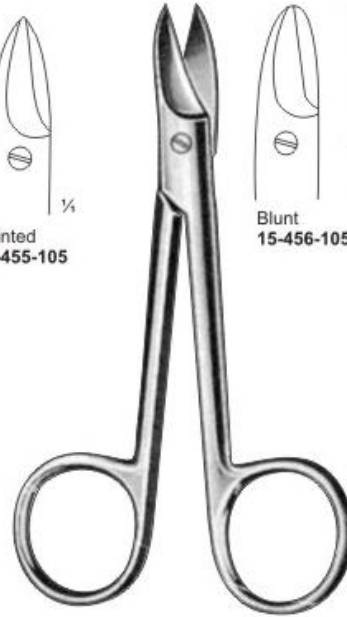
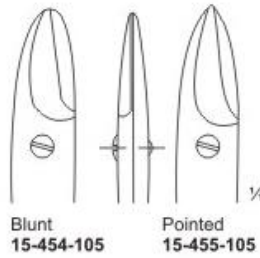

BEEBEE
10.5 cm, 4"
Curved

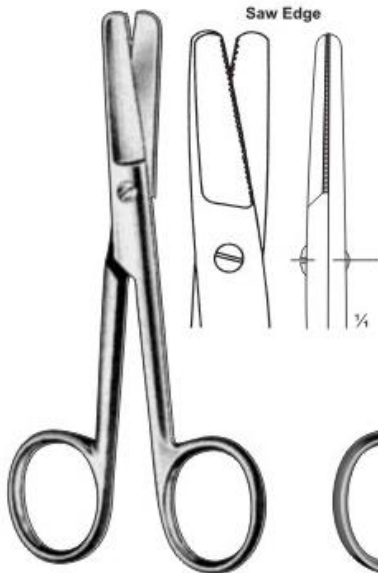
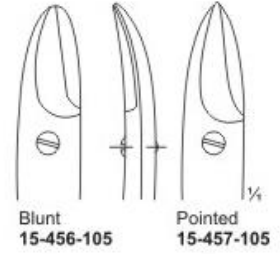

HARVEY
15-458-125
12.5 cm, 5"

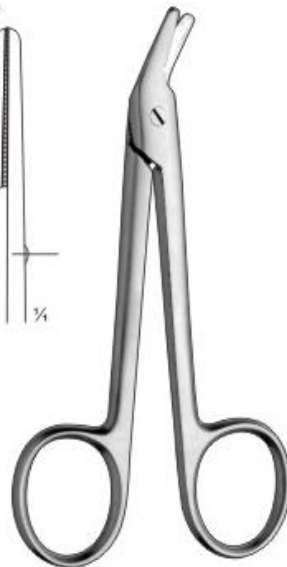

WIRE CUTTING
15-459-115
11.5 cm, 4 ½"



SCHUKNECHT
15-460-100
10.0 cm, 4"



15-461-110
11.0 cm, 4 ¼"



15-462-090
9.0 cm, 3 1/2"
15-463-105
10.5 cm, 4"

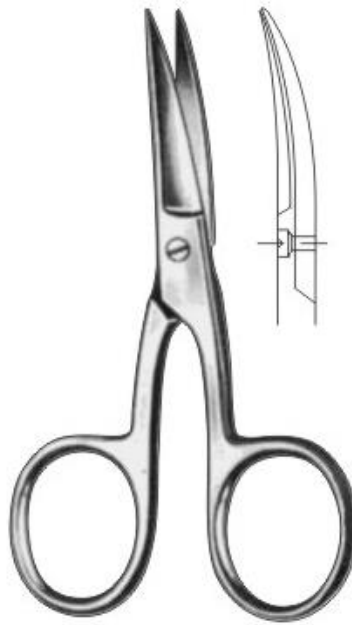

15-464-090
9.0 cm, 3 1/2"
15-465-105
10.5 cm, 4"



15-466-090
9.0 cm, 3 1/2"
15-466-105
10.5 cm, 4"



15-467-130
13.0 cm, 5"
15-467-155
15.5 cm, 6"



NAIL SCISSORS
15-468-090
9 cm, 3 1/2"
Curved



NAIL SCISSORS
15-469-090
9 cm, 3 1/2"
Curved



NAIL SCISSORS
15-470-090
9 cm, 3 1/2"
Arrow Point
Curved



15-471-090
9.0 cm, 3 1/2"
15-472-105
10.5 cm, 4"

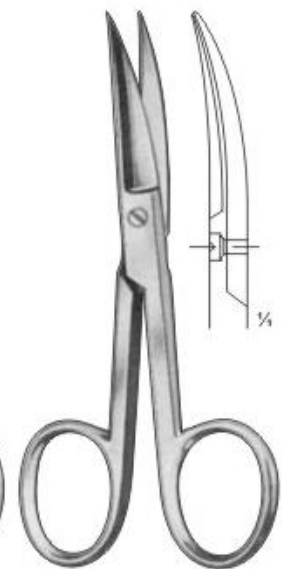

15-473-090
9.0 cm, 3 1/2"
15-474-105
10.5 cm, 4"

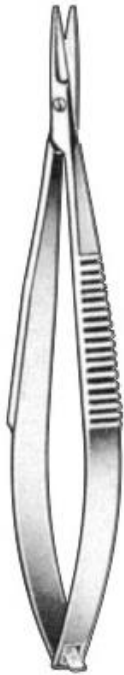

CASTROVIEJO
9.0 cm, 3 1/2"

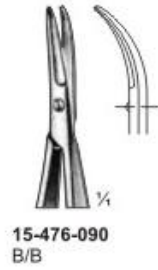

CASTROVIEJO
10.0 cm, 4"



CASTROVIEJO
10.0 cm, 4"



NOYES
A 15-481-120
B 15-482-120
C 15-483-120
12 cm, 4 3/4"



NOYES
15-484-120
12 cm, 4 3/4"

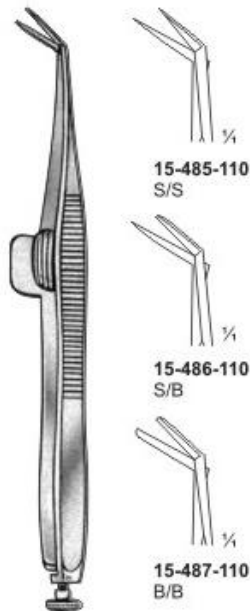

WECKER
11.0 cm, 4 1/4"



BARRAQUER
15-488-055
15-489-055
15-490-055
5.5 cm, 2 1/4"



CASTROVIEJO
15-491-110
11.0 cm, 4 1/4"



CASTROVIEJO
15-492-110
11.0 cm, 4 1/4"



TROUTMAN
15-493-100
10.0 cm, 4"



TROUTMAN
15-494-100
10.0 cm, 4"



WESTCOTT
15-495-110
11.0 cm, 4 1/4"



WESTCOTT
15-496-110
11.0 cm, 4 1/4"



CASTROVIEJO
15-497-100
10.0 cm, 4"



CASTROVIEJO
15-498-100
10.0 cm, 4"





15-499-120
12.0 cm, 4 3/4"



WESTCOTT
15-500-115
11.5 cm, 4 1/2"



WESTCOTT
15-501-115
11.5 cm, 4 1/2"



WESTCOTT

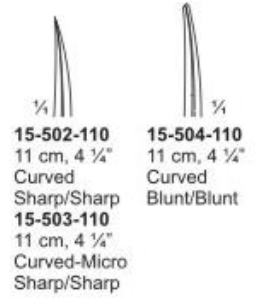

NOYES
15-505-150
15.0 cm, 6"



15-506-145
14.5 cm, 5 3/4"



14 cm

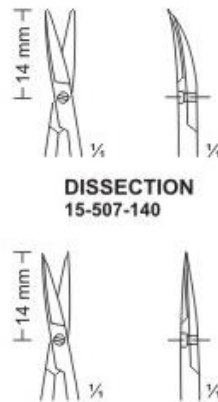

MICRO SCISSOR
15-509-180
18 cm, 7"



15-510-180
18.0 cm, 7" Str.
15-511-180
18.0 cm, 7" Cvd.



DISSECTION
15-512-180
18 cm, 7" B/B

ADVENTITIA
15-513-180
18 cm, 7" S/S



15-514-145
14.5 cm, 5 3/4" Str.
15-515-145
14.5 cm, 5 3/4" Cvd.



15-516-180
18.0 cm, 7"



15.0 cm, 6"

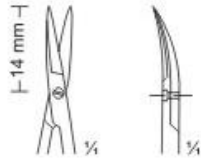

DISSECTION
15-517-150

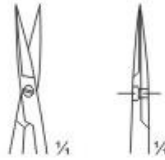

ADVENTITIA
15-518-150

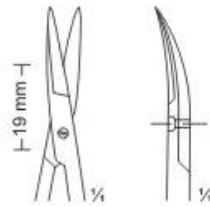

DISSECTION
15-519-150

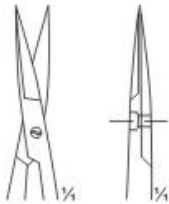

ADVENTITIA
15-520-150

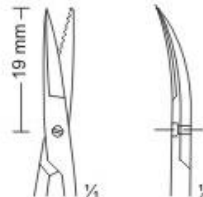

DISSECTION
15-521-150

-Nerve-

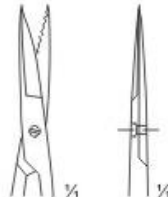

ADVENTITIA
15-522-150



11.0 cm, 4 1/4"

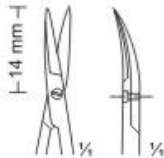

DISSECTION
15-523-110

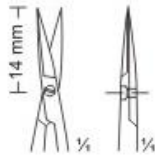

ADVENTITIA
15-524-110

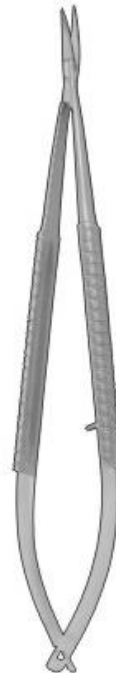

DISSECTING SCISSORS
15-525-110
11 cm, 4 1/4"



18.5 cm, 7 1/4"

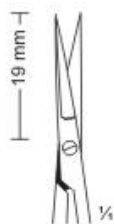

15-526-185
Str.



15-527-185
Cvd.



16 cm, 6 1/4"
20 cm, 8"
22 cm, 8 3/4"



15-528-160
15-529-200
15-530-220



15-531-160
15-532-200
15-533-220



15-534-160
15-535-200
15-536-220



15-537-160
15-538-200
15-539-220



16 cm, 6 1/4"
20 cm, 8"
22 cm, 8 3/4"

15-540-160
15-541-200
15-542-220



15-543-160
15-544-200
15-545-220



18.0 cm, 7"



15-546-180
25°



15-547-180
45°



15-548-180
60°



15-549-180
90°



15-550-180
125°



18.0 cm, 7"



15-551-180
25°



15-552-180
45°



15-553-180
60°



15-554-180
90°



15-555-180
125°

Plaster scissors



15-556-200
20 cm, 8"



UNIVERSAL (Colour Available)
15-557-145 14.5 cm, 5 3/4"
 143 C/290 F Autoclavable
15-558-150 15 cm, 6"
 143 C/290 F Autoclavable
15-559-160 16 cm, 6 1/4"
 143 C/290 F Autoclavable
15-560-180 18 cm, 7"
 143 C/290 F Autoclavable



UNIVERSAL BANDAGE
15-561-120
12 cm, 5"



ESMARCH
15-562-180
18 cm, 7"

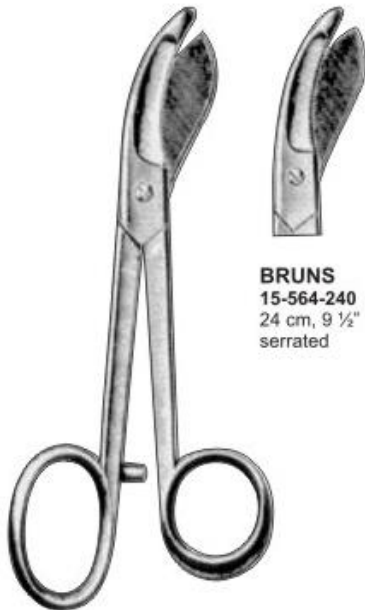

BRUNS
15-564-240
24 cm, 9 1/2"
serrated



LISTER
15-565-190
Exentric
19 cm, 7 1/2"



BERGMANN
15-566-230
23 cm, 9"



ESMARCH
15-567-200
20 cm, 8"
15-568-220
22 cm, 8 3/4"



BRAUN-STADLER
15-569-140
14 cm, 5 1/2"



BRAUN-STADLER
15-570-200
20 cm, 8"



MODIFIED-USA
15-571-100
10 cm, 4"



15-572-200
20 cm, 8"



WALDMANN
15-573-180
18 cm, 7"

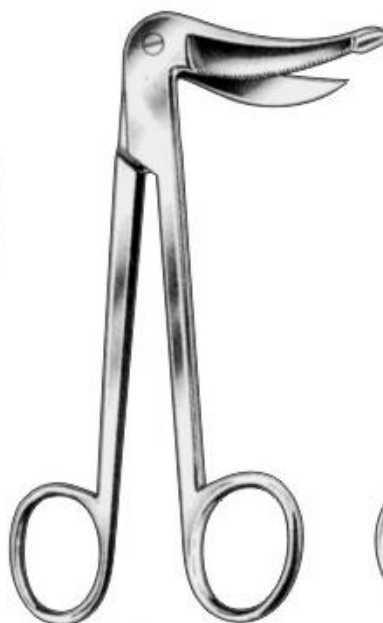

MARBACH
15-574-155
15.5 cm, 6"



SCHUMACHER
15-575-160
16 cm, 6 1/4"



BUSCH
15-576-130
13 cm, 5 1/4"
15-577-160
16 cm, 6 1/4"



BERGMANN
15-578-180
18 cm, 7"



15-579-170
17 cm, 6 1/4"

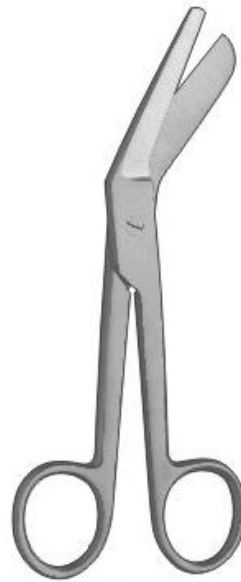

BURNHAM BANDAGE
15-580-140
14 cm, 5 1/2"



SMITH (MOD. USA)
15-581-160 16 cm, 6 1/4"
15-582-180 18 cm, 7"
15-583-200 20 cm, 8"
15-584-230 23 cm, 9"



LORENZ
15-585-230
23 cm, 9"



KNOWLES
15-586-140
14 cm, 5 1/2"

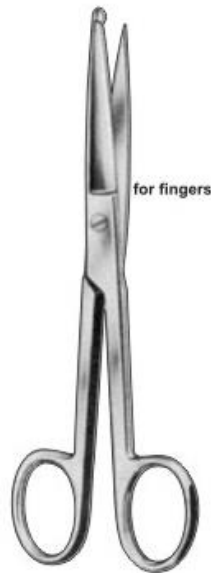

KNOWLES
15-587-210
14 cm, 5 1/2"



LISTER
15-588-210
21.0 cm, 8 1/4"

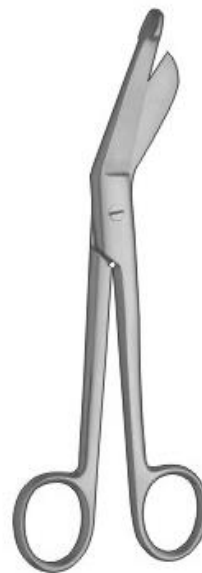

LISTER BANDAGE
15-589-140 14 cm, 5 1/2"
15-590-160 16 cm, 6 1/4"
15-591-180 18 cm, 7"
15-592-200 20 cm, 8"



LISTER-EXCENTRIC
15-593-160 16 cm, 6 1/4"
15-594-190 19 cm, 7 1/2"

Plaster Shears



STILLE
15-595-260
 26 cm, 10 1/4"
15-596-360
 Spare Blade

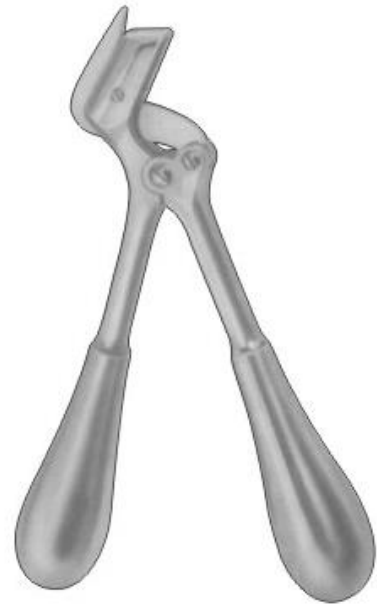

STILLE
15-597-230
 23 cm, 9"
15-598-230
 Spare blade



STILLE
15-599-370
 37 cm, 14 1/2"
15-600-370
 Spare blade



STILLE
15-601-240
 24 cm, 9 1/2"
15-602-240
 Spare blade



HENING
15-603-270
27 cm, 10 3/4"



1/4
15-604-230
23 cm, 9"
3 Prong

MODEL USA

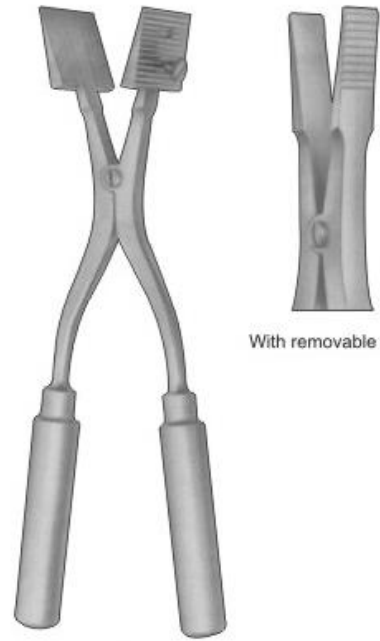

With removable jaws

15-605-290
29 cm, 11 1/2"



WOLFF
15-606-180 18 cm, 7"
15-607-240 24 cm, 9 1/2"



**ENGEL
PLASTER SAW**
15-608-155
15.5 cm, 6"



CHARRIERE
15-609-250 25 cm, 10"
15-610-270 27 cm, 10 3/4"
Double saw



SAFETY
 15-611-090 Straight
 15-612-090 Curved
 9.0 cm, 3 1/2"



GOLDMAN-FOX
 15-613-090 Straight
 15-614-090 Curved
 9.0 cm, 3 1/2"



STEVENS TENOTOMY
 15-615-090 Straight
 15-616-090 Curved
 9.0 cm, 3 1/2"



STEVENS TENOTOMY
 15-617-114 Straight
 15-618-114 Curved
 11.4 cm, 4 1/2"



BABY METZENBAUM
 15-619-114
 11.4 cm, 4 1/2"
 straight



BABY METZENBAUM
 15-620-114
 11.4 cm, 4 1/2"
 Curved



IRIS
 15-621-090
 9.0 cm, 3 1/2"
 15-622-114
 11.4 cm, 4 1/2"
 Straight



IRIS
 15-623-090
 15-624-090
 9.0 cm, 3 1/2"
 Curved



IRIS
 15-625-114
 11.4 cm, 4 1/2"



METZENBAUM
15-626-140 14 cm, 5 1/2"
15-627-180 18 cm, 7"
 Straight



METZENBAUM
15-628-140 14 cm, 5 1/2"
15-629-180 18 cm, 7"
 Curved



METZENBAUM
15-630-230 Straight
15-631-230 Curved
 23 cm, 9"



METZENBAUM
15-632-140
 14 cm, 5 1/2"



STANDARD
15-633-140
 14 cm, 5 1/2"
 Straight



STANDARD
15-634-140
 14 cm, 5 1/2"
 Curved



METZENBAUM
15-635-140 14 cm, 5 1/2"
15-636-160 16 cm, 6 1/4"
15-637-180 18 cm, 7"
15-638-220 20 cm, 8"
15-639-230 23 cm, 9"
15-640-280 28 cm, 11"
15-641-300 30 cm, 11 1/4"



MAYO
15-642-230
23 cm, 9"
Straight



MAYO
15-643-230
23 cm, 9"
Curved



JAMISON
15-644-140 14.0 cm, 5 1/2"
15-645-178 17.8 cm, 7"
Curved



POTTS-SMITH
15-646-178 Angled 25°
15-647-178 Angled 45°
15-648-178 Angled 60°
17.8 cm, 7"



MAYO
15-649-140 14 cm, 5 1/2"
15-650-150 15 cm, 6"
15-651-180 18 cm, 7"
15-652-200 20 cm, 8"
15-653-230 23 cm, 9"

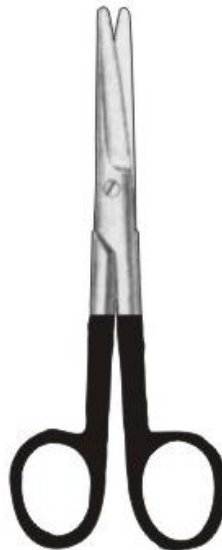

MAYO
15-654-140 14 cm, 5 1/2"
15-655-170 17 cm, 6 3/4"
Straight



MAYO
15-656-140 14 cm, 5 1/2"
15-657-170 17 cm, 6 3/4"
Curved

Operating scissors T.C. inserted



STANDARD

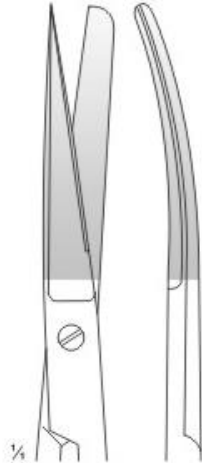

15-658-145
14.5 cm, 5 3/4" Straight
15-659-145
14.5 cm, 5 3/4" Curved

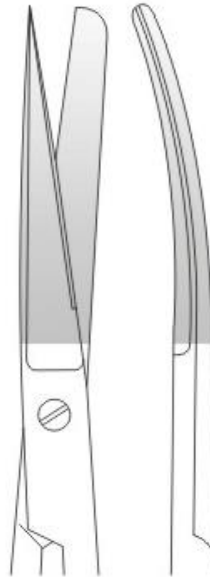

15-660-165
16.5 cm, 6 1/2" Straight
15-661-165
16.5 cm, 6 1/2" Curved

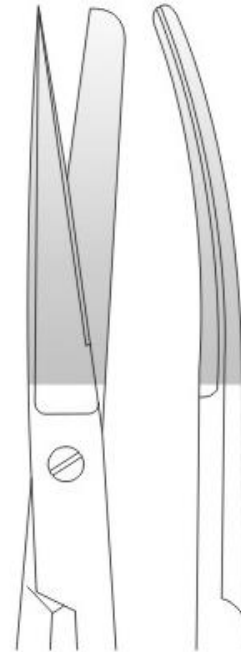

15-662-185
18.5 cm, 7 1/4" Straight
15-663-185
18.5 cm, 7 1/4" Curved



STANDARD

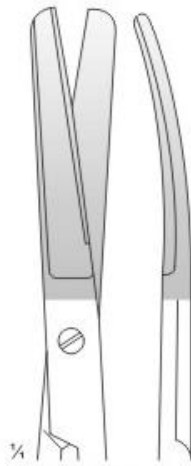

15-664-145
14.5 cm, 5 3/4" Straight
15-665-145
14.5 cm, 5 3/4" Curved



15-666-165
16.5 cm, 6 1/2" Straight
15-667-165
16.5 cm, 6 1/2" Curved

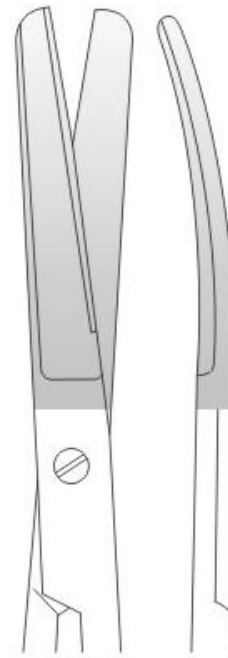

15-668-185
18.5 cm, 7 1/4" Straight
15-669-185
18.5 cm, 7 1/4" Curved

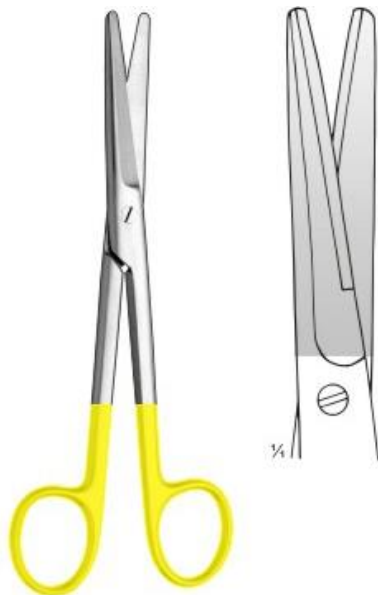

MAYO
15-670-140 14 cm, 5 1/2"
15-671-170 17 cm, 6 3/4"
15-672-230 23 cm, 9"
 blunt/blunt

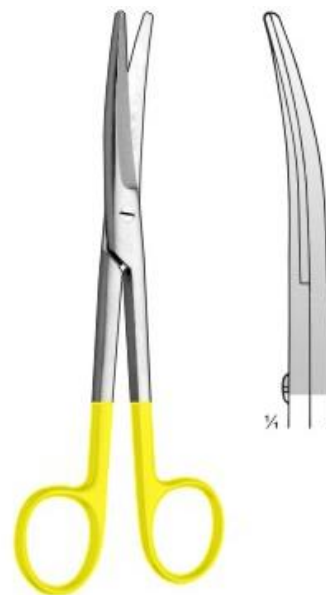

MAYO
15-673-140 14 cm, 5 1/2"
15-674-170 17 cm, 6 3/4"
15-675-230 23 cm, 9"
 blunt/blunt, Cvd.



STANDARD

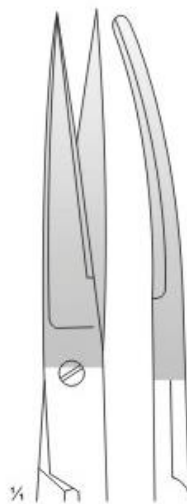

15-676-145
 14.5 cm, 5 3/4" Straight
15-677-145
 14.5 cm, 5 3/4" Curved

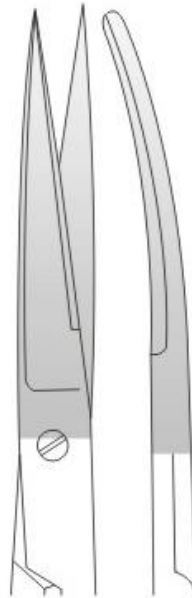

15-678-165
 16.5 cm, 6 1/2" Straight
15-679-165
 16.5 cm, 6 1/2" Curved

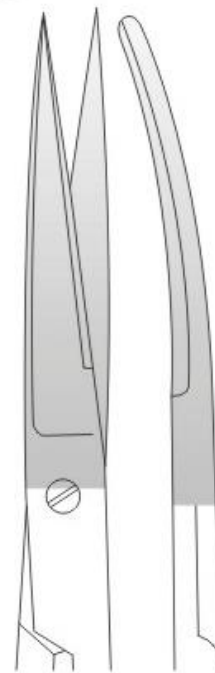

15-680-185
 18.5 cm, 7 1/4" Straight
15-681-185
 18.5 cm, 7 1/4" Curved



MAYO-STILLE
15-682-150 15 cm, 6"
15-683-170 17 cm, 6 3/4"
 blunt/blunt, Cvd.

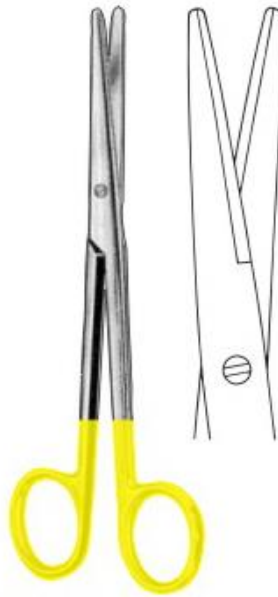

LEXER
15-684-160 16 cm, 6 1/4"
15-685-215 21.5 cm, 8 1/2"
 blunt/blunt, Str.



LEXER
15-686-160 16 cm, 6 1/4"
15-687-215 21.5 cm, 8 1/2"
 blunt/blunt, Cvd.



PARAMETRIUM
 23 cm, 9"



15-688-230
 blunt/blunt, Str.



15-689-230
 blunt/blunt, Cvd.

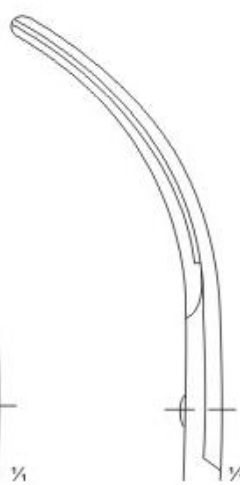

15-690-230
 blunt/blunt, Full Cvd.



MAYO-STILLE
15-691-150 15 cm, 6"
15-692-170 17 cm, 6 3/4"
 blunt/blunt, Str.



GOLDMAN-FOX
15-693-130
13.0 cm, 5"



GOLDMAN-FOX
15-694-130
13.0 cm, 5"



SIMS
15-695-230
23.0 cm, 9"
Straight



SIMS
15-696-230
23.0 cm, 9"
Curved

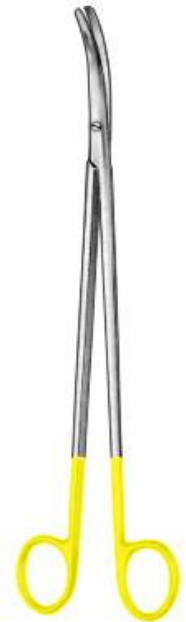

CARDINALE
15-697-280
28.0 cm, 11"



**METZENBAUM
DELICATE**
Blunt / Blunt
Curved

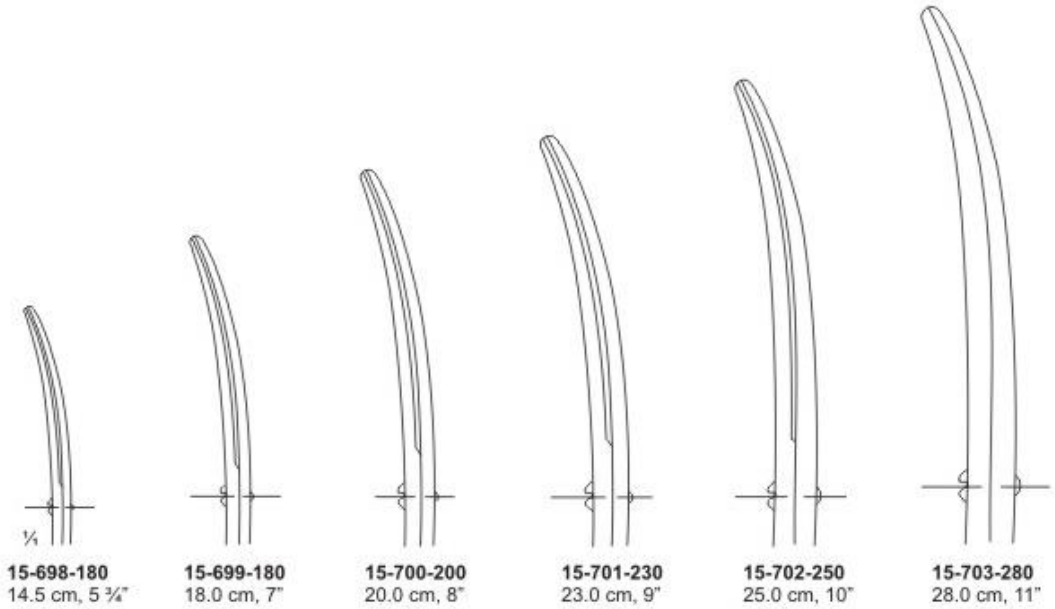

**METZENBAUM
DELICATE**
Blunt / Blunt
Straight

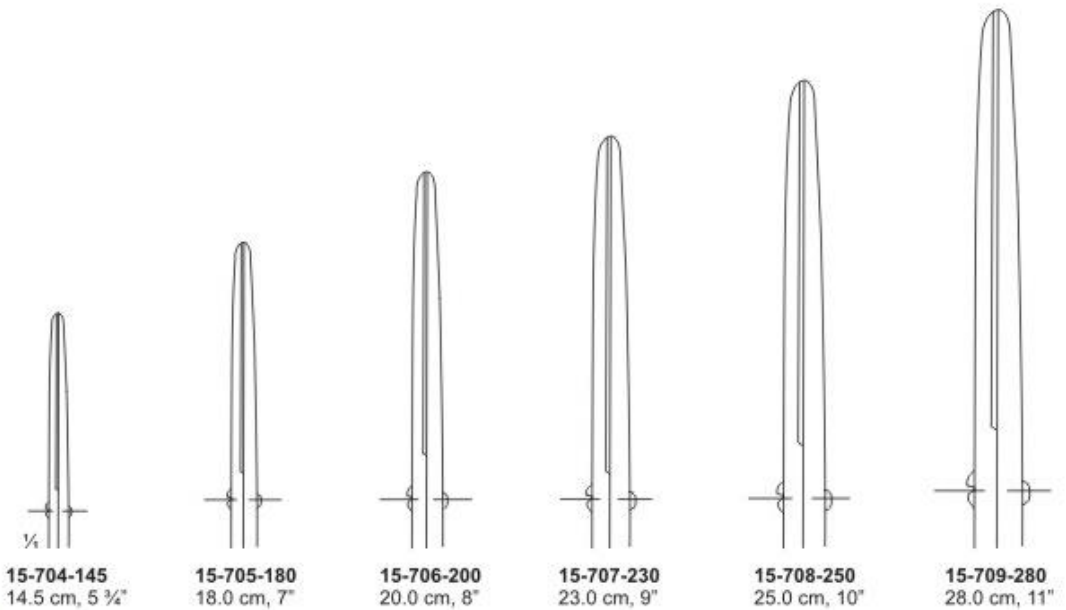



**METZENBAUM
DELICATE**
Sharp / Sharp
Curved

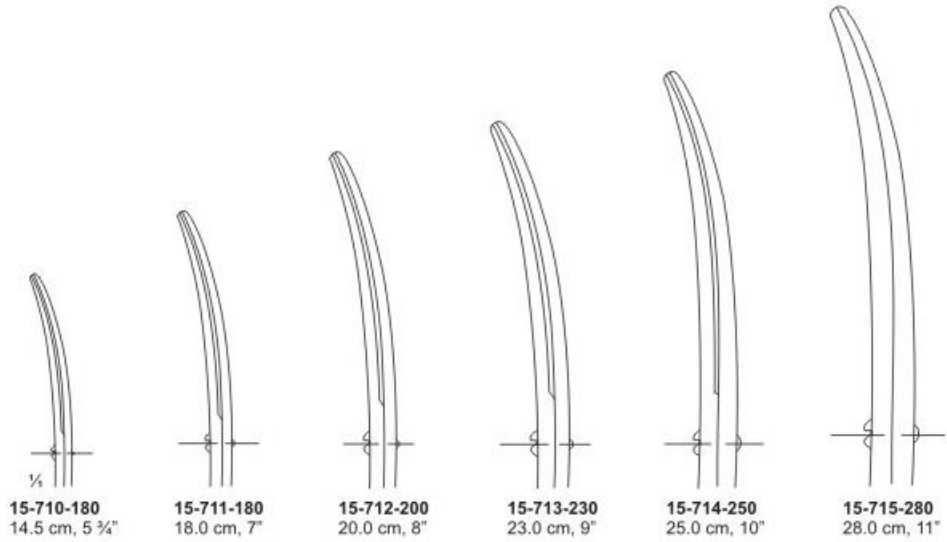

**METZENBAUM
DELICATE**
Sharp / Sharp
Straight

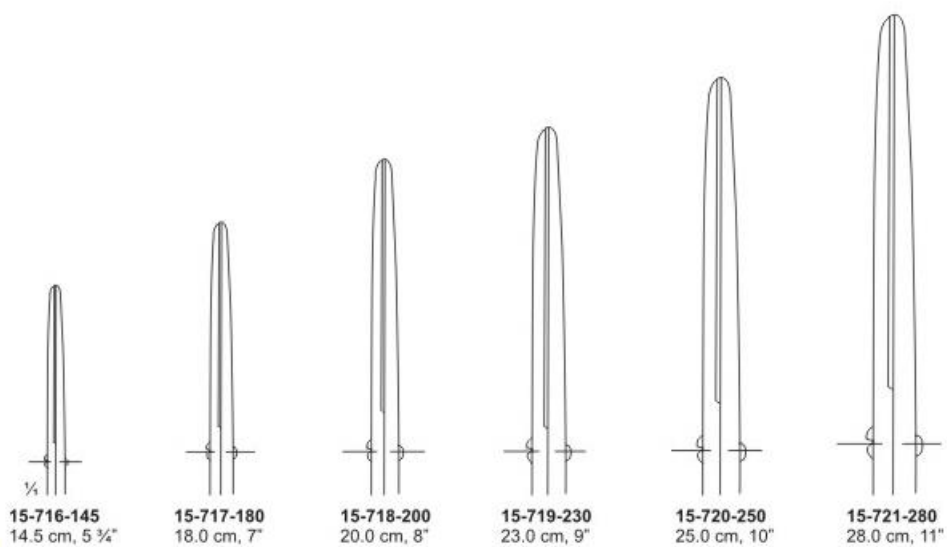

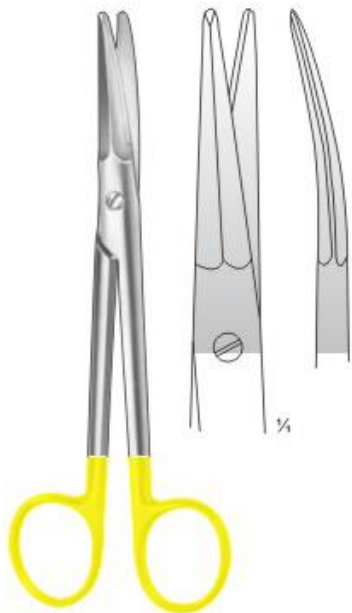

REES
15-722-180
18 cm, 7"

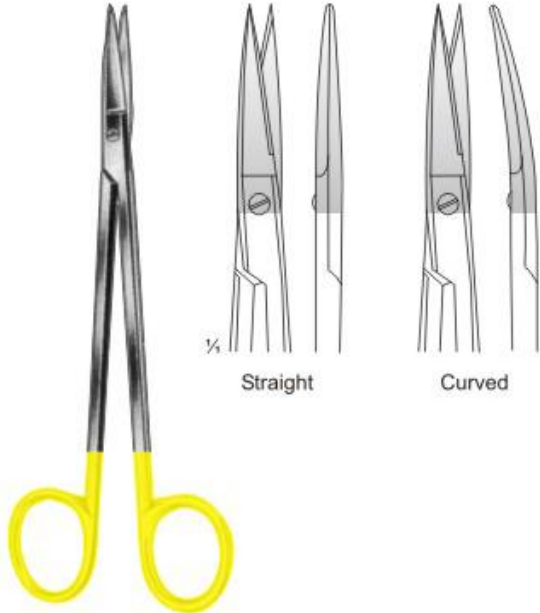

KELLY
15-723-160
15-724-160
16 cm, 6 1/4"

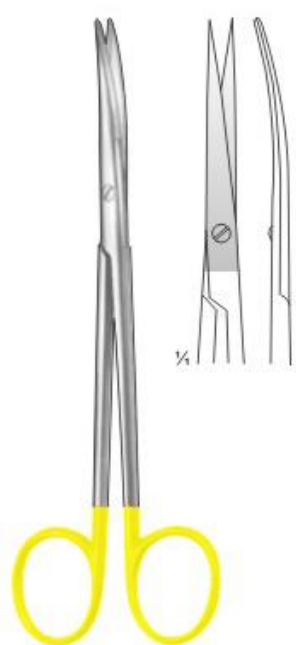

METZENBAUM-LAHEY
15-725-140 14.0 cm, 5 1/2" Sharp/Sharp
15-726-205 20.5 cm, 8" Blunt/Blunt
15-727-230 23.0 cm, 9" Blunt/Blunt

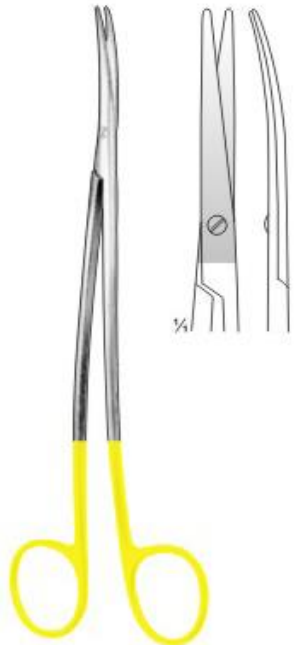

METZENBAUM-LAHEY
15-728-180 18.0 cm, 7" Str.
15-729-205 20.5 cm, 8" Cvd.
15-730-230 23.0 cm, 9" Cvd.

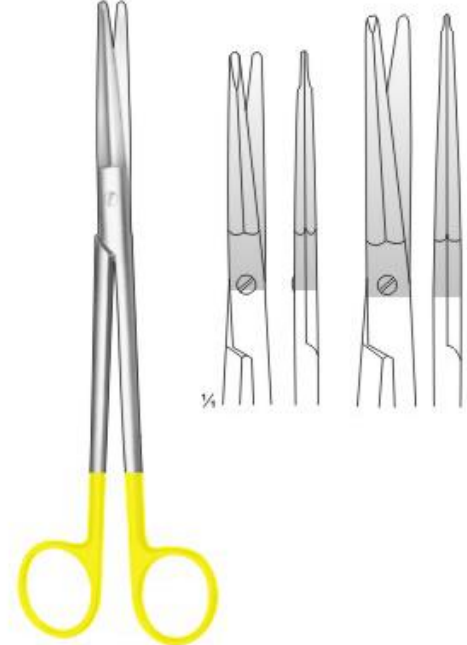

GORNEY
15-731-200 20 cm, 8"
15-732-230 23 cm, 9"



JOSEPH
15-733-145
14.5 cm, 5 1/2"

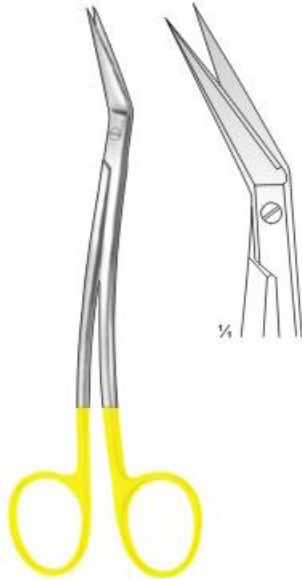

GUM SCISSORS
Locklin
15-734-160
16 cm, 6 1/4"

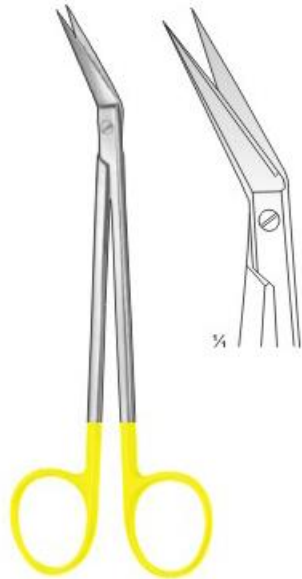

GUM SCISSORS
Locklin
15-735-160
16 cm, 6 1/4"



RAGNELL
15-736-125
12.5 cm, 5"

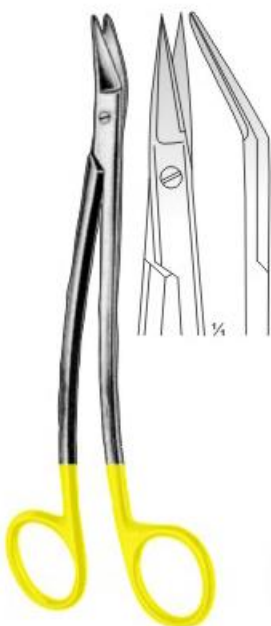

DEAN
15-737-175
17.5 cm, 6 3/4"

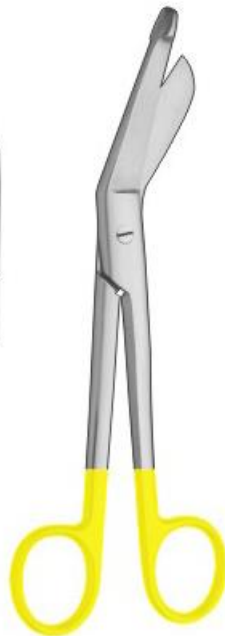

LISTER BANDAGE
15-738-140 14 cm, 5 1/2"
15-739-160 16 cm, 6 1/4"
15-740-180 18 cm, 7"
15-741-200 20 cm, 8"



BRUNS SCISSORS
15-742-210
21 cm, 8 1/4"



DEBAKEY

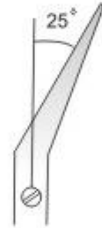

15-743-165
16.5 cm 6 1/2"

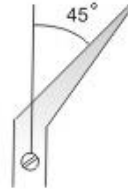

15-744-180
18.0 cm 7"

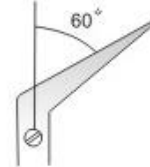

15-745-185
18.5cm 7 1/4"



15-746-190
19.0 cm 7 1/2"

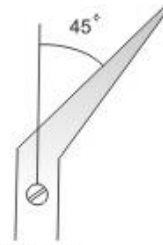

15-747-220
22.0 cm 8 3/4"

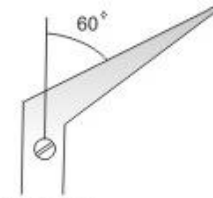

15-748-230
23.0 cm 9"



POTTS-SMITH
19.0 cm, 7 1/2"



25°
15-749-190



45°
15-750-190



60°
15-751-190



IRIS
15-752-110
11cm 4 1/2"



WIRE CUTTING
15-753-115
11.5 cm, 4 1/2"

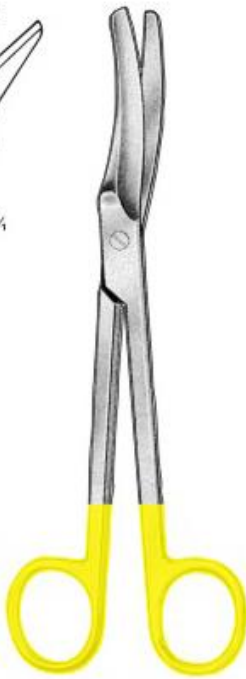

15-754-200
20.0 cm, 8"



FOMON
15-755-145
14.5cm, 5 3/4"

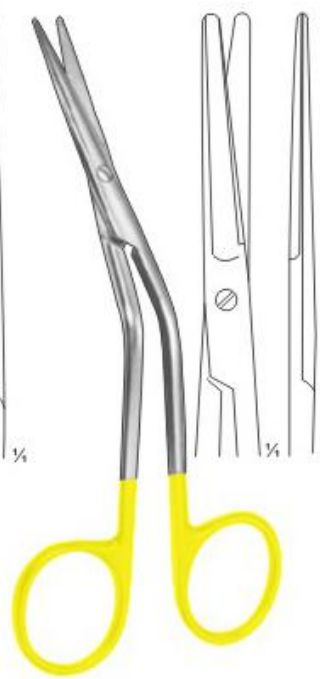

COTTLE
15-756-160
16 cm, 6 1/4"



IRIS
15-757-115
11.5cm 4 1/2"



IRIS
15-758-115
11.5 cm Straight
15-759-115
11.5 cm Curved

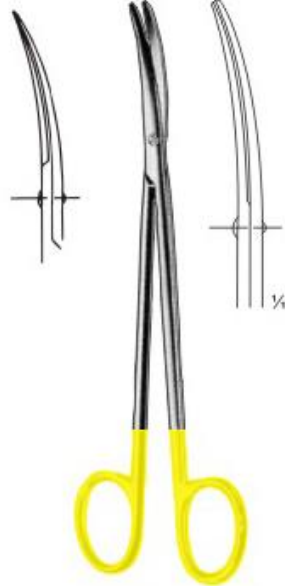

TOENNIS-ADSON
15-760-175
17.5 cm, 6 3/4"



STRABISMUS
15-761-115
11.5 cm, 4 1/2"
Curved