



AME SURGICAL INSTRUMENTS

Hemostatic Forceps



AME GLOBAL FZE
www.ameglobalfze.com

- **HAEMOSTATIC FORCEPS**
- **TOWEL CLAMPS**
- **TUBING FORCEPS**
- **SPONGE FORCEPS**

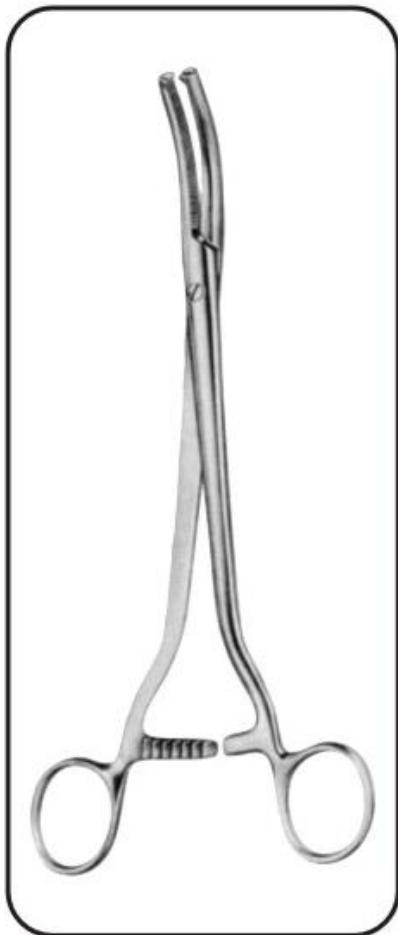



Hemostatic Forceps



CARREL
17-001-085
8.5 cm, 3 1/4"

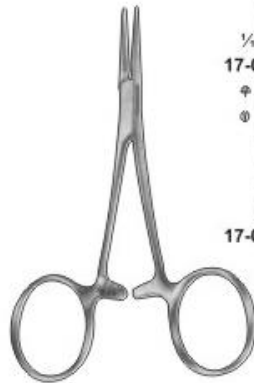

BABY-MOSQUITO (HARTMANN)
10.0 cm, 4"

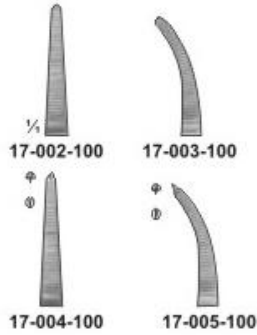

MICRO-HALSTED
12.5 cm, 5"

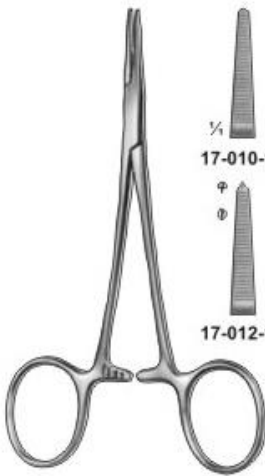
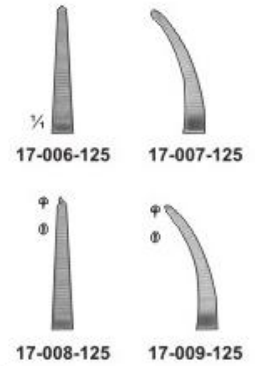

HALSTED-MOSQUITO
12.5 cm, 5"

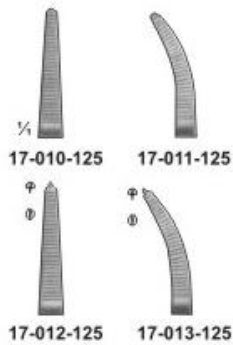

PROVIDENCE-HOSPITAL
14.0 cm, 5 1/2"

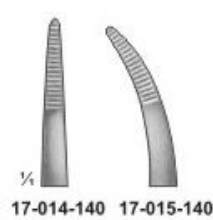

KELLY
14.0 cm, 5 1/2"



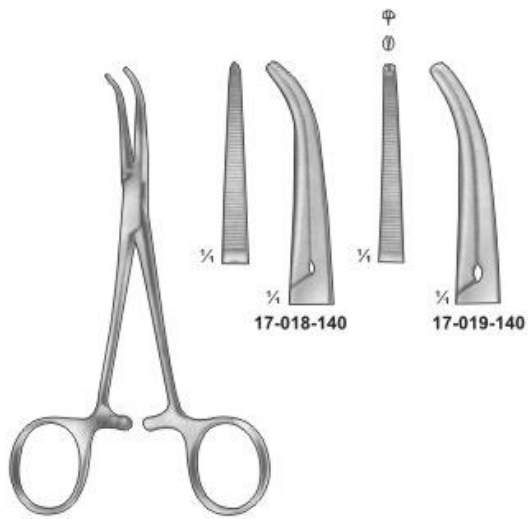

DANDY
14.0 cm, 5 1/2"
Curved sideways

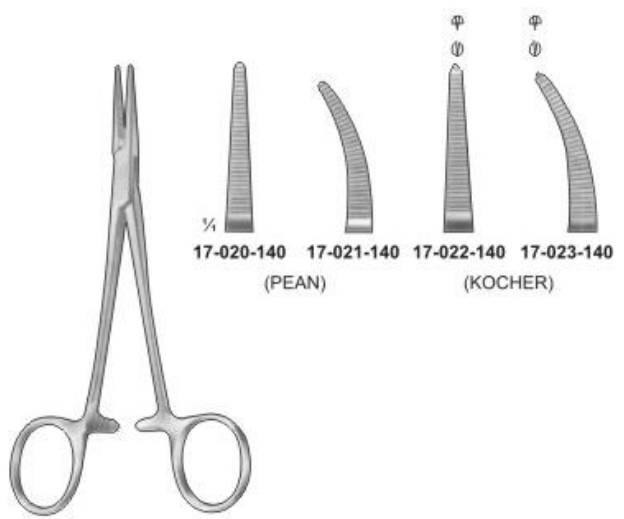

BABY-CRILE
14.0 cm, 5 1/2"

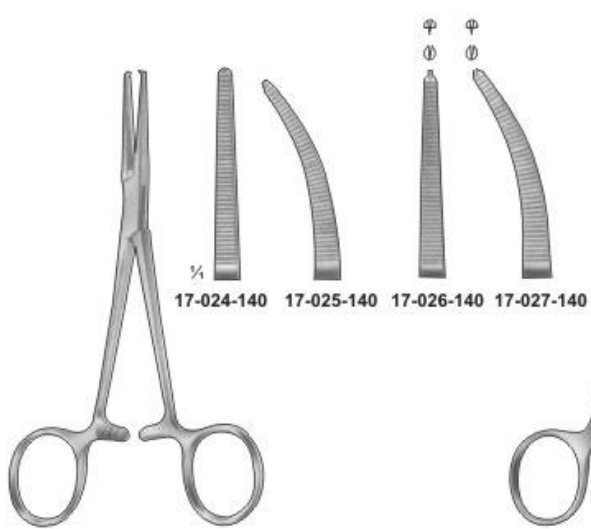

CRILE
14.0 cm, 5 1/2"

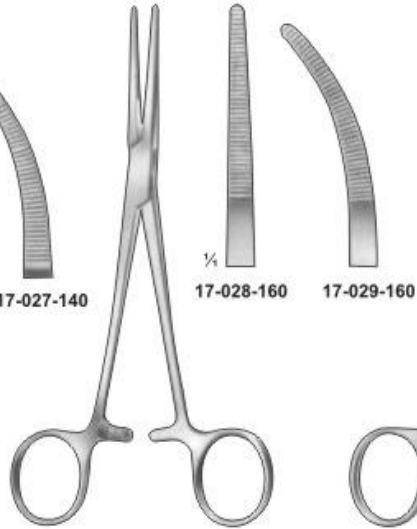

RANKIN
16.0 cm, 6 1/4"

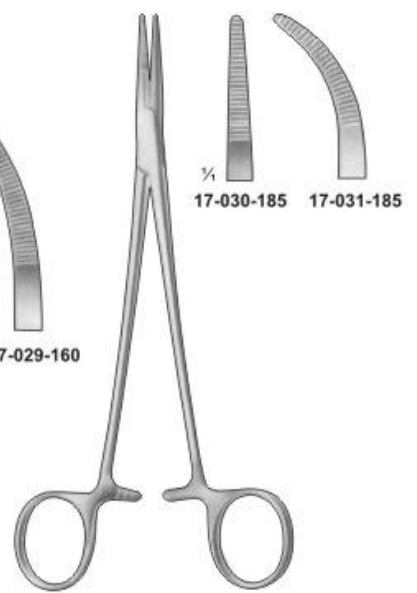

ADSON
18.5 cm, 7 1/4"



Hemostatic Forceps

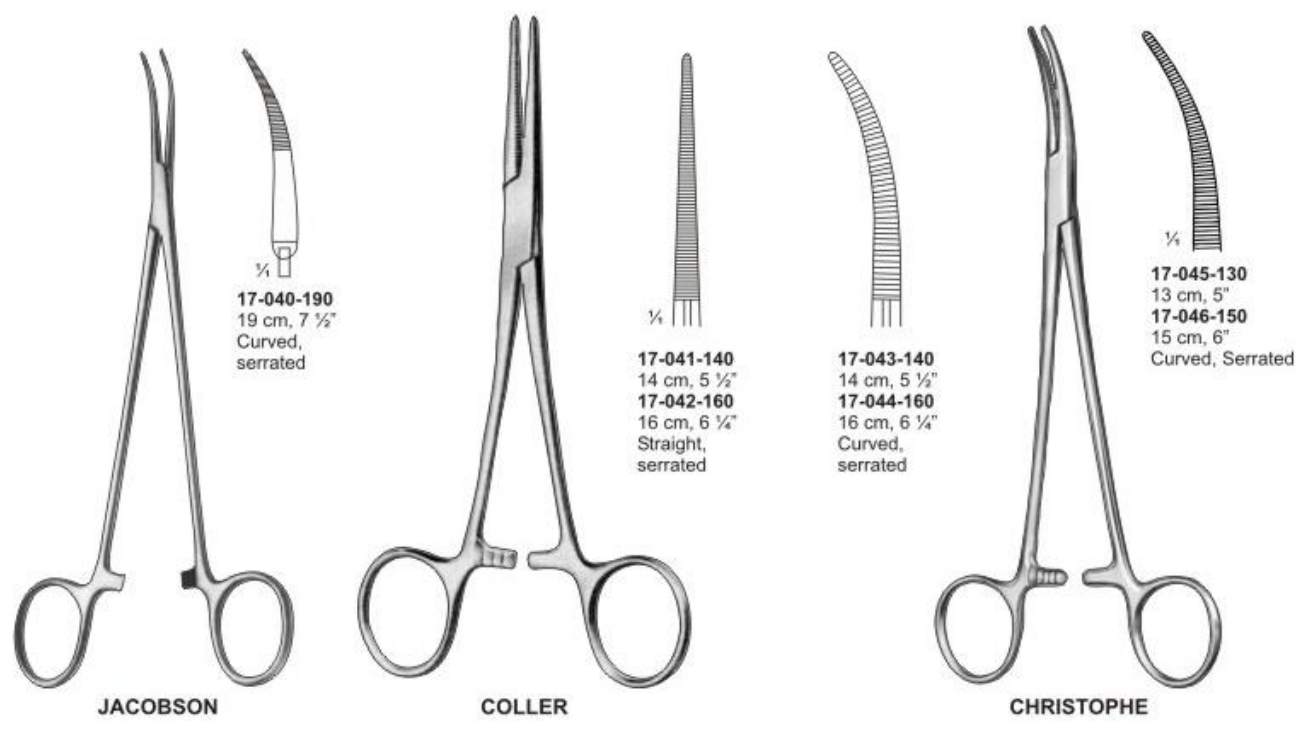
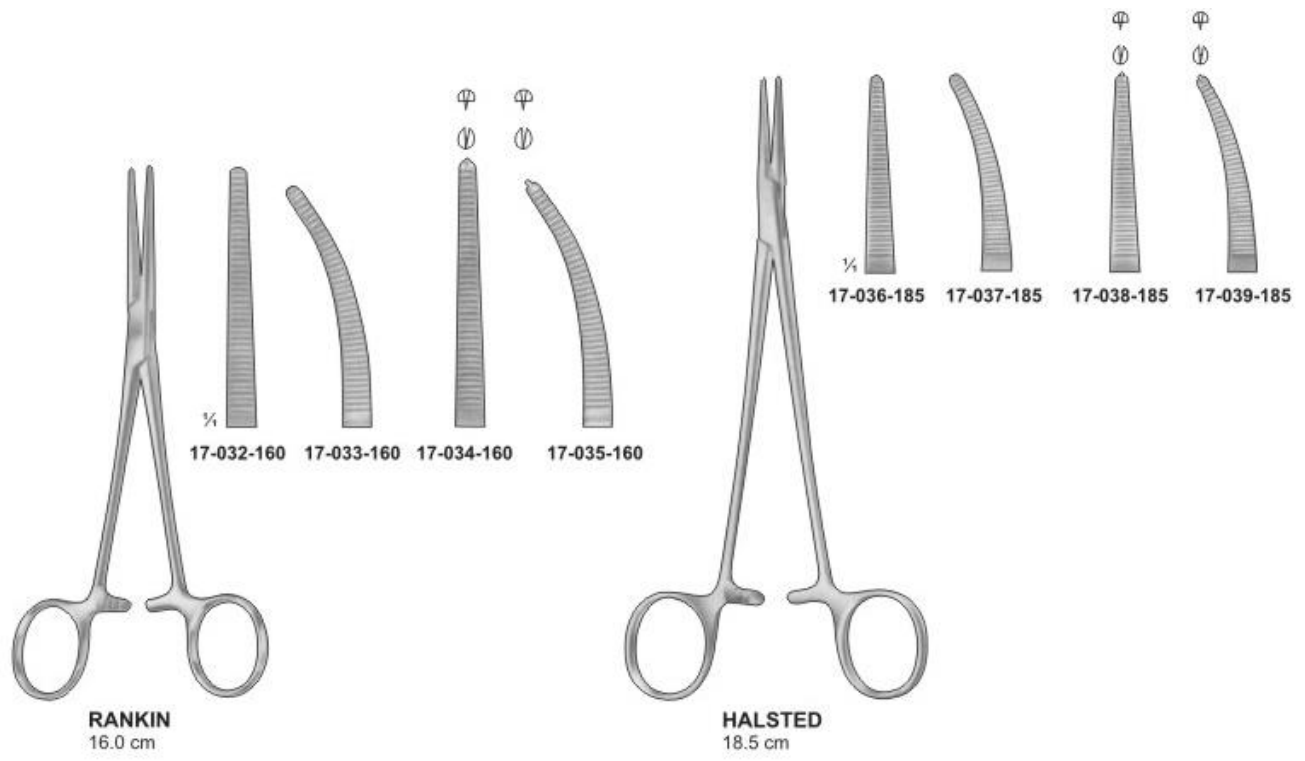

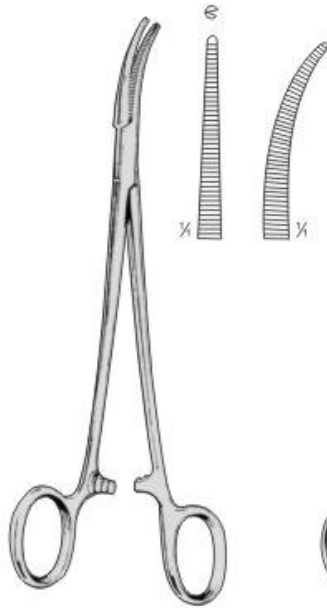

ADSON
17-047-180 18.0 cm, 7"
 Straight, box joint,
 as above but curved flat.
 Straight, box joint,
 one into two teeth



ADSON 1:2

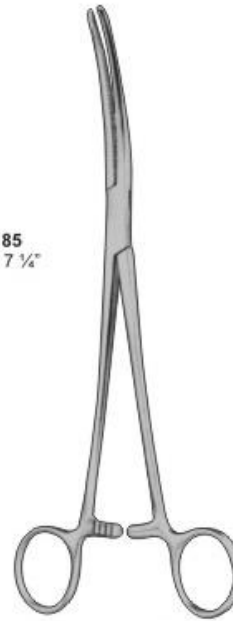
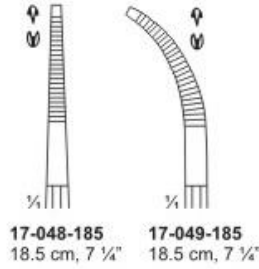

SAROOT

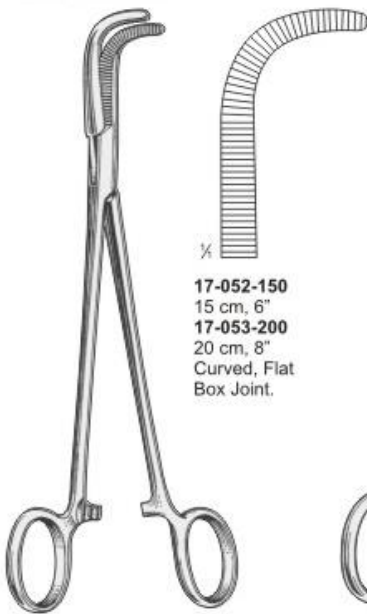
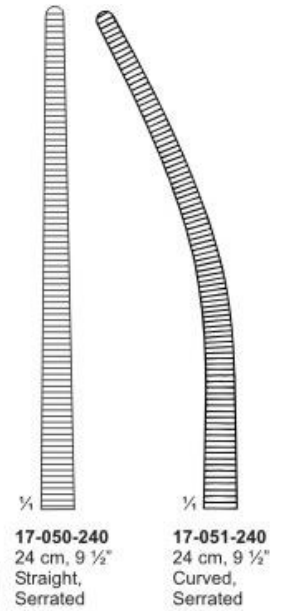

O'SHAUGHNESSY

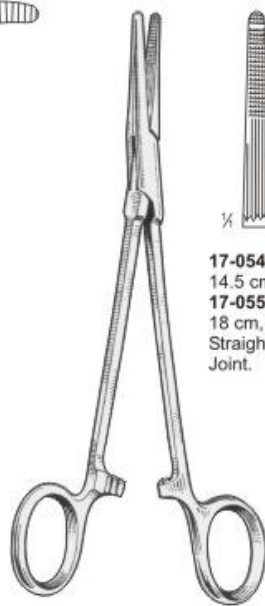
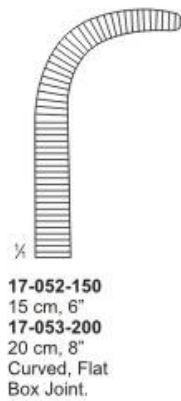

GREY TURNER

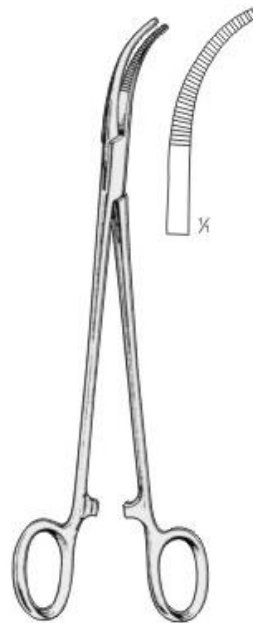

SAWTELL
17-056-185 18.5 cm, 7 1/4"
 curved on flat joint

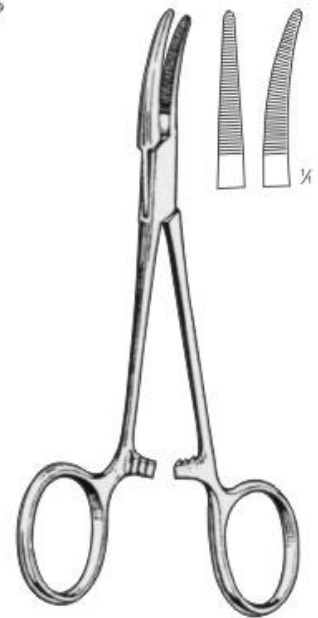

DUNHILL
17-057-130
 13.0 cm, 5"
 Straight, box joint, as
 above but curved on flat.



Hemostatic Forceps



CAIRNS
17-058-145
14.5 cm, 5 3/4"
Straight, box joint, as above but curved on flat.

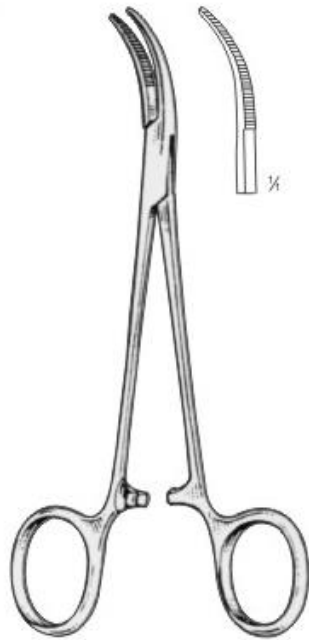

CAIRNS
17-059-145
14.5 cm, 5 3/4"
curved laterally, joint



17-060-270
27 cm, 10 3/4"
Right Angle, Serrated

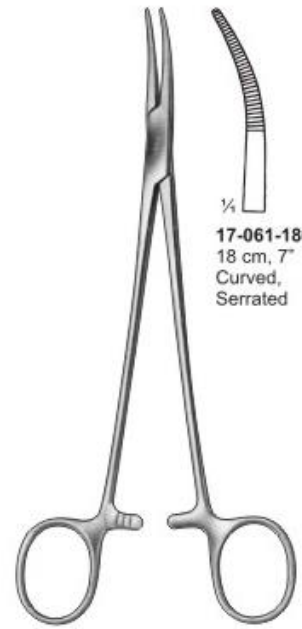

17-061-180
18 cm, 7"
Curved, Serrated

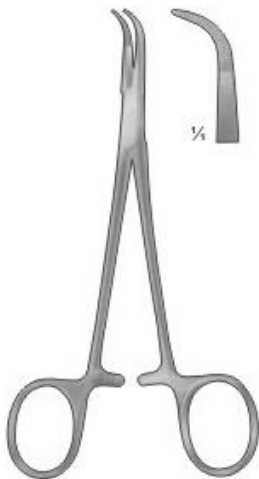

MICRO-ADSON
17-062-140
14.0 cm

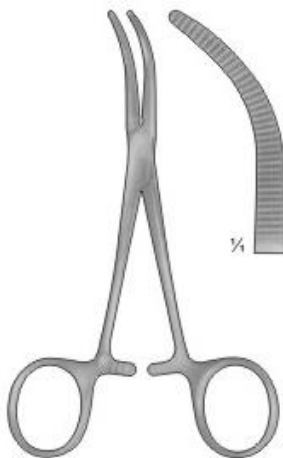

BABY-OVERHOLT
17-063-135
13.5 cm

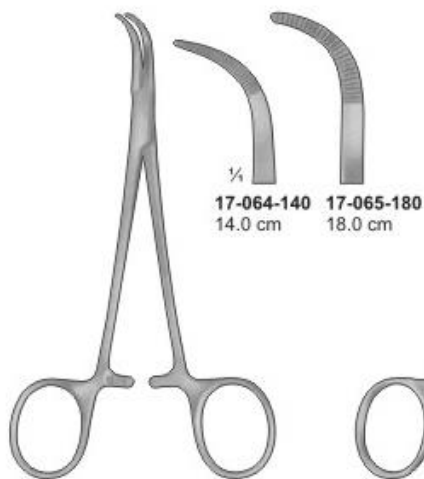

17-064-140 14.0 cm
17-065-180 18.0 cm

BABY-MIXTER

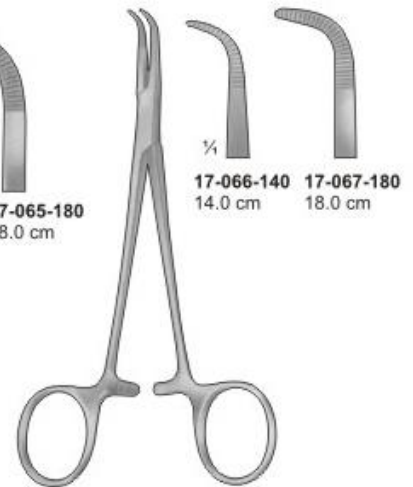

17-066-140 14.0 cm
17-067-180 18.0 cm

BABY-ADSON

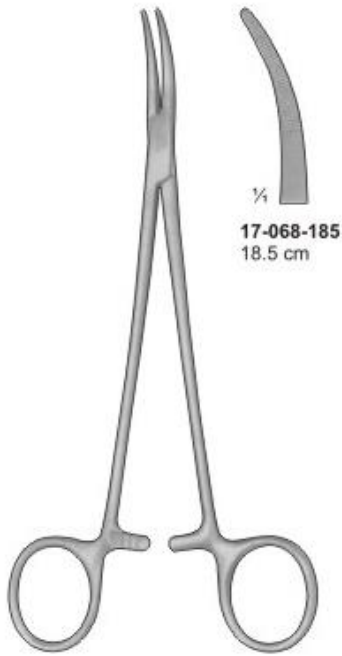

17-068-185
18.5 cm

NISSEN

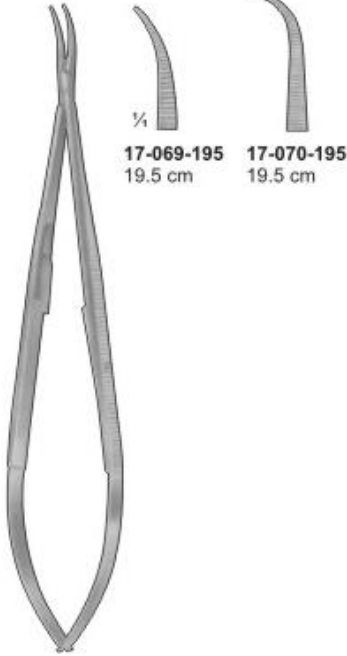

17-069-195 19.5 cm
17-070-195 19.5 cm

YASARGIL

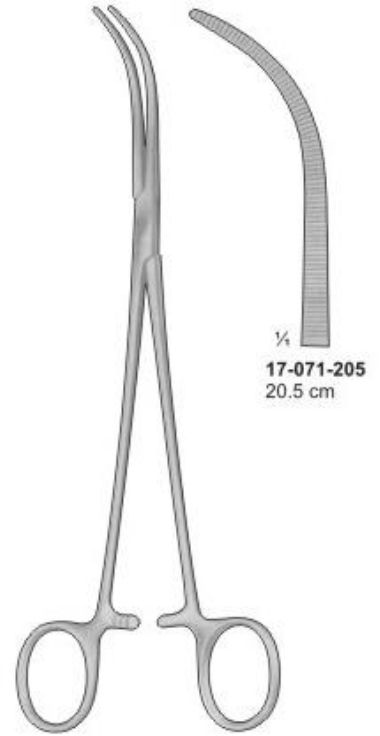

17-071-205
20.5 cm

OVERHOLT-MIXTER



17-072-130 13.0 cm
17-073-140 14.0 cm
17-074-130 13.0 cm
17-075-140 14.0 cm

17-076-130 13.0 cm
17-077-150 15.0 cm
17-078-175 17.5 cm
17-079-200 20 cm
17-080-130 13.0 cm
17-081-150 15.0 cm
17-082-175 17.5 cm
17-083-200 20 cm

PEAN
Slender Type

SPENCER-WELLS
Slender Type



Hemostatic Forceps

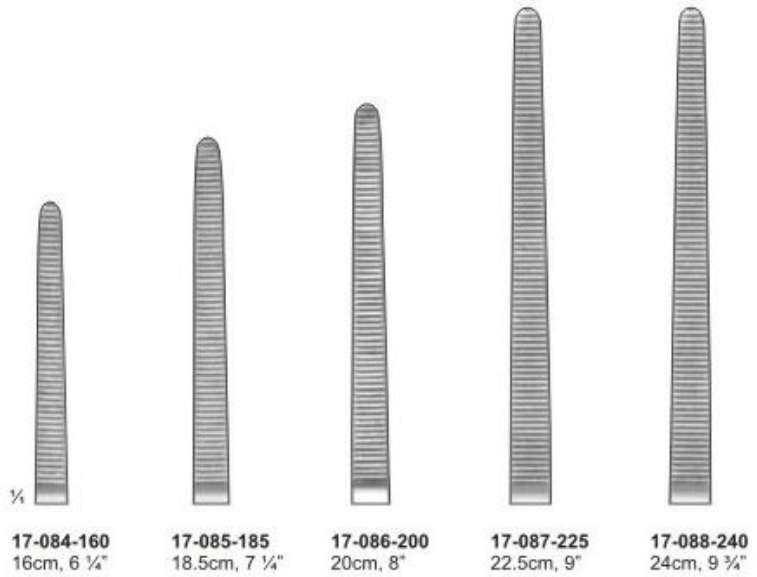

ROCHESTER-PEAN

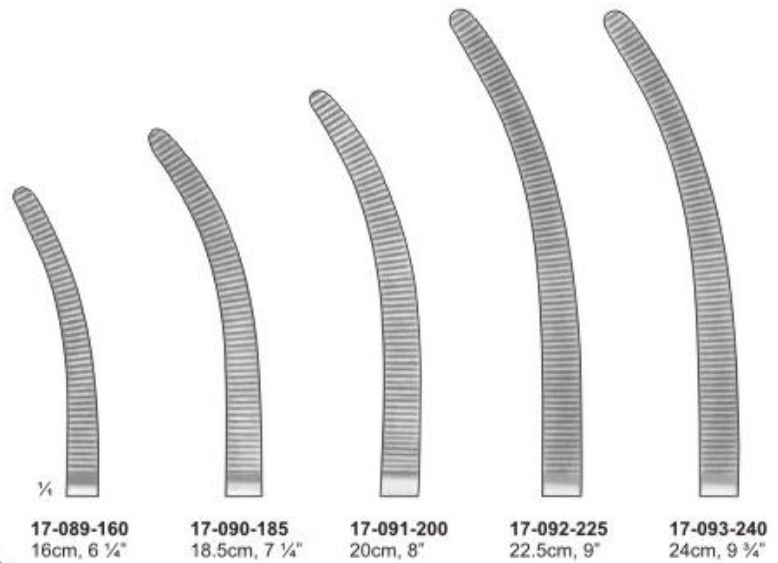



KOCHER-OCHSNER

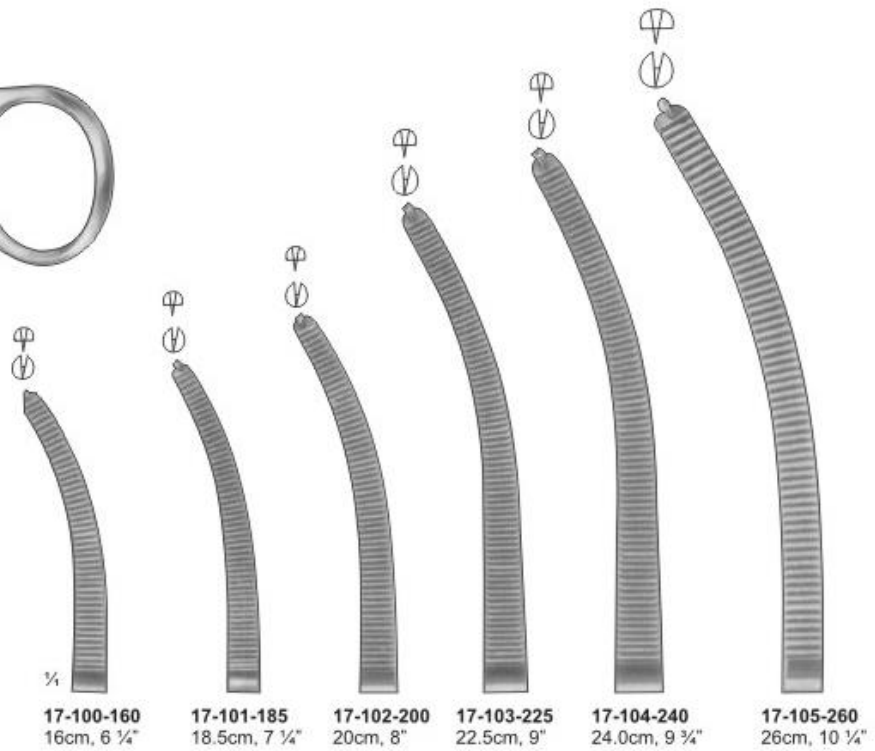
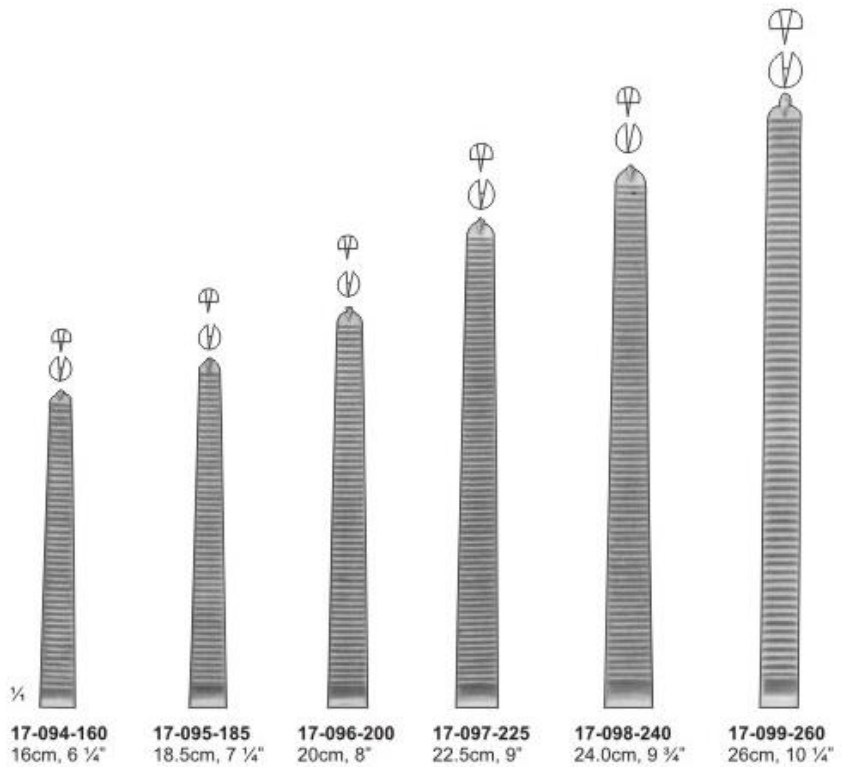



Hemostatic Forceps



PEAN

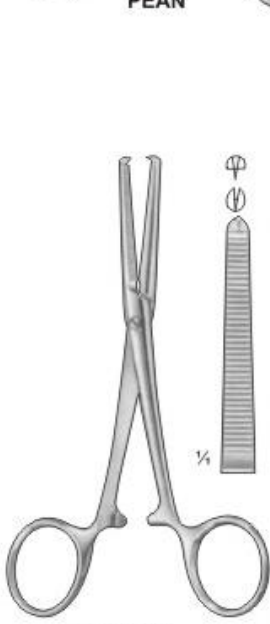
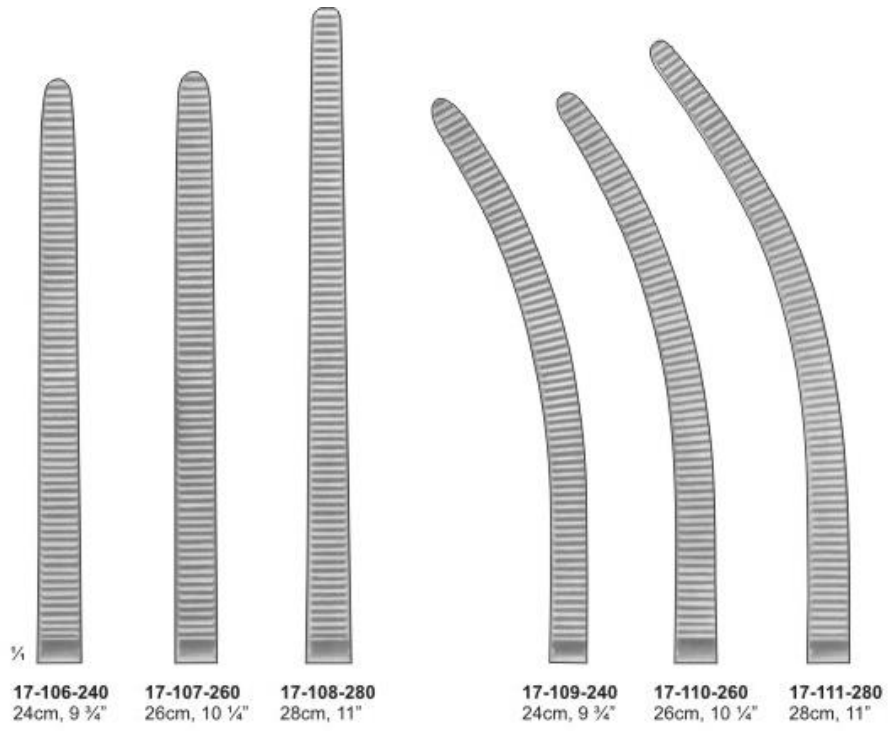

KOCHER
Strong Pattern
17-112-145
14.5cm, 5 ¾"

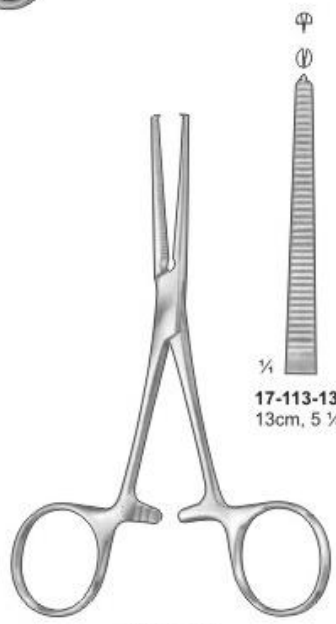

KOCHER

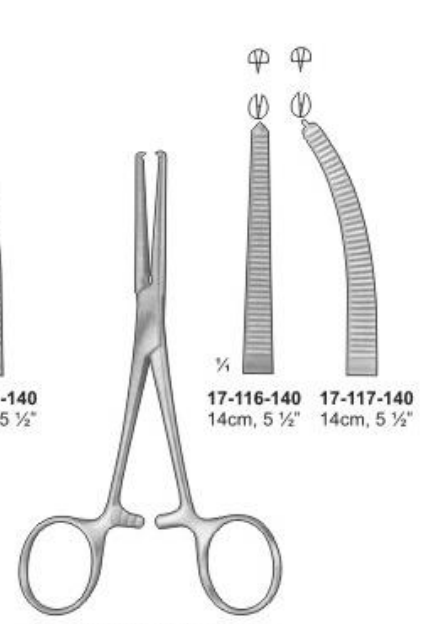
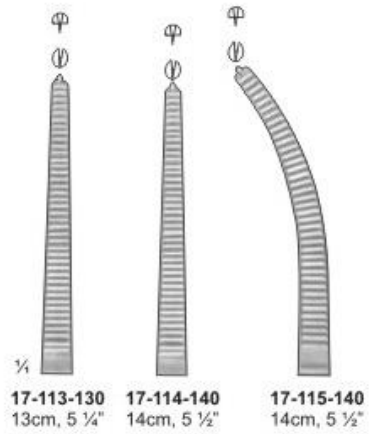

ROCHESTER-OCHSNER

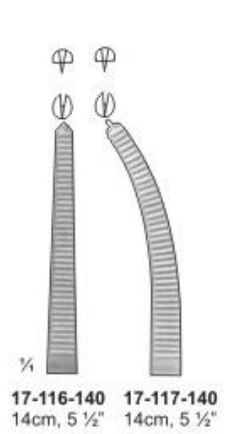

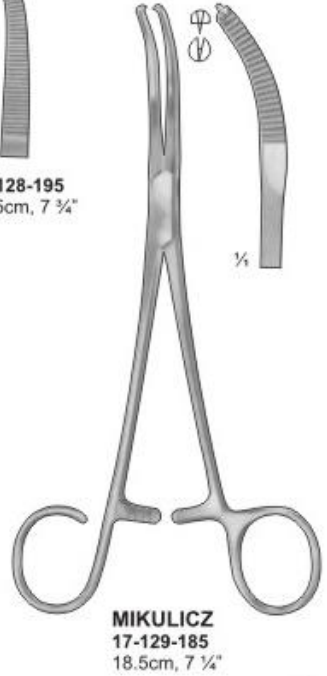
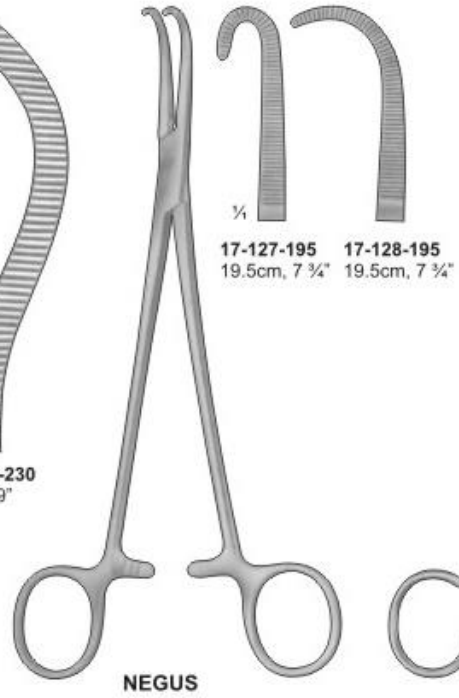
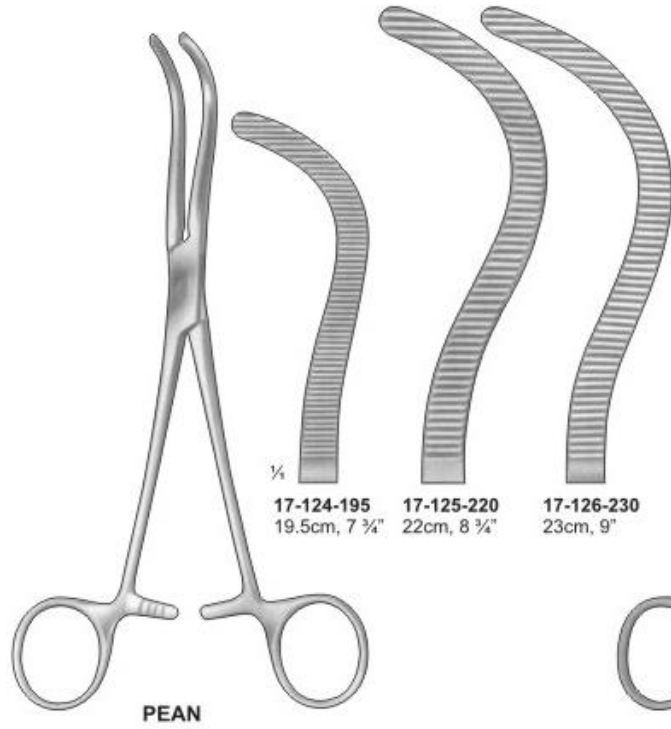
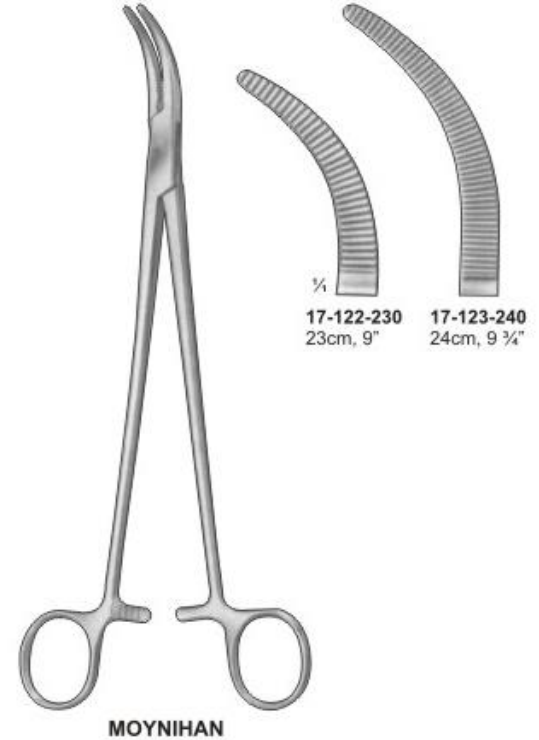
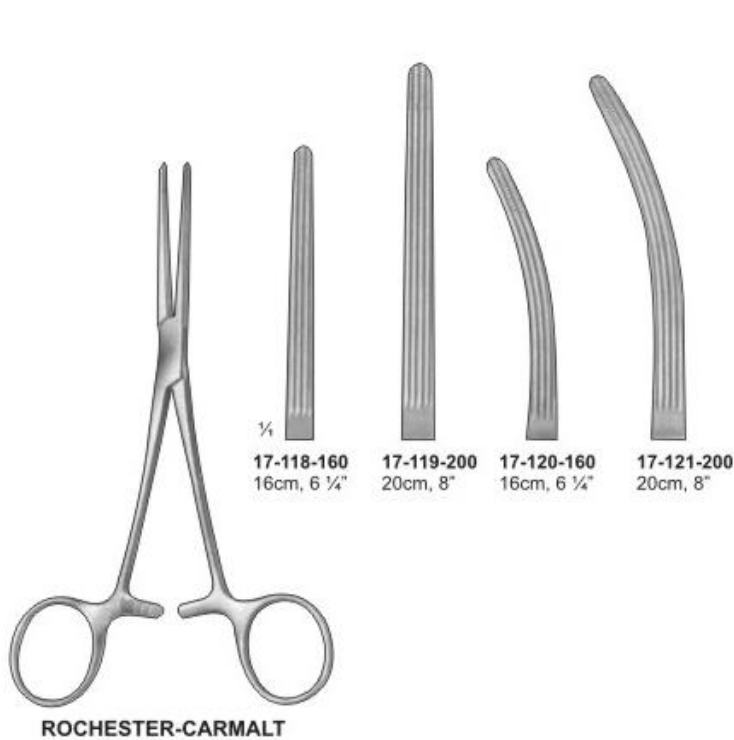



Hemostatic Forceps

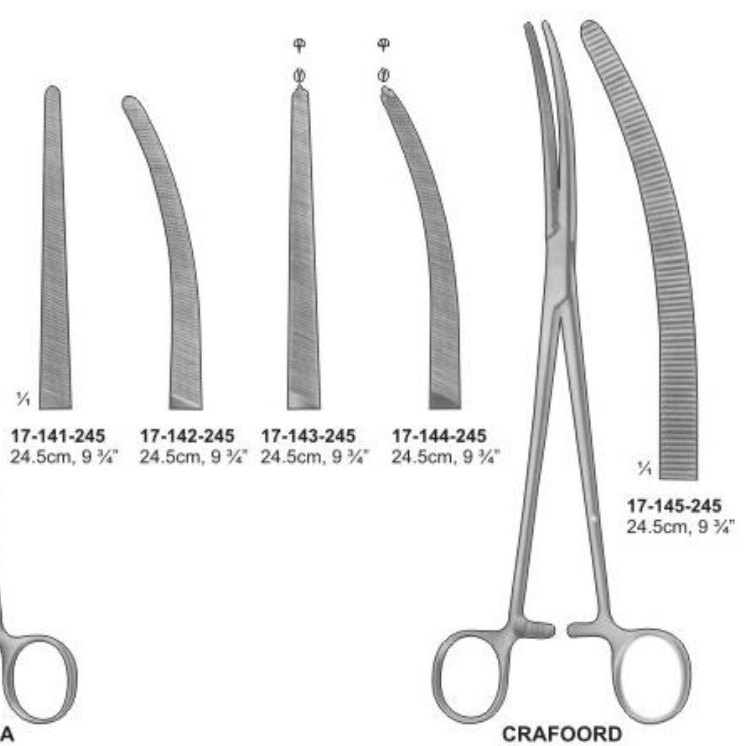
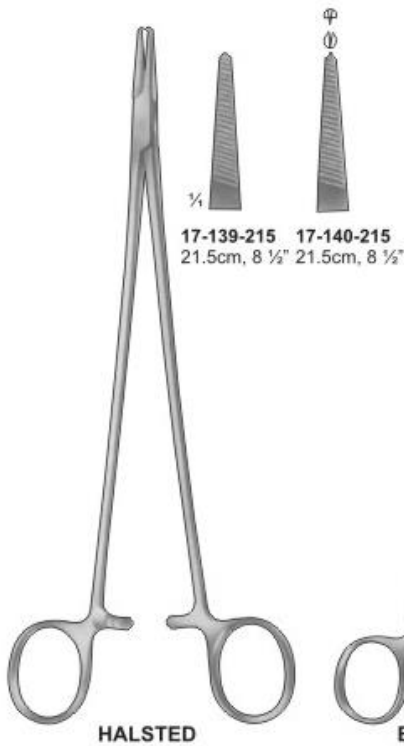
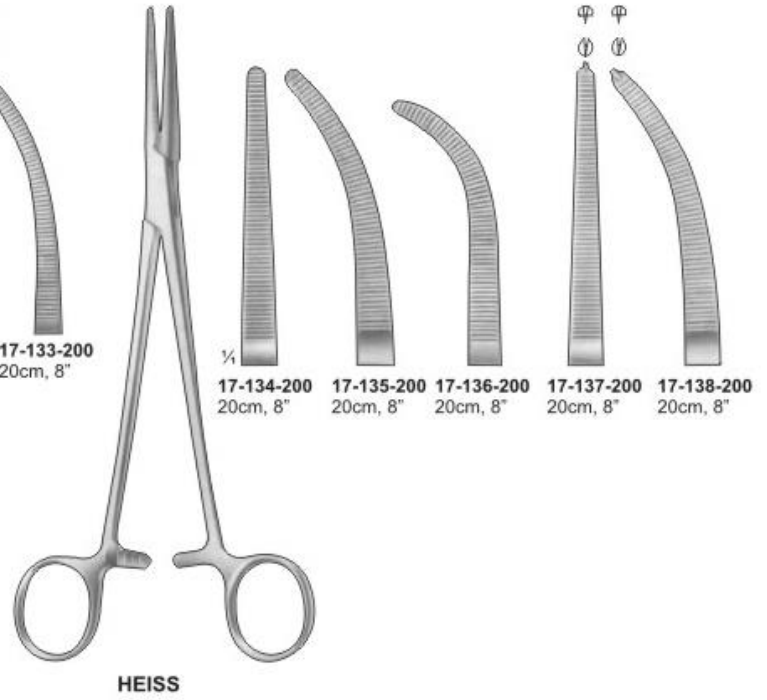
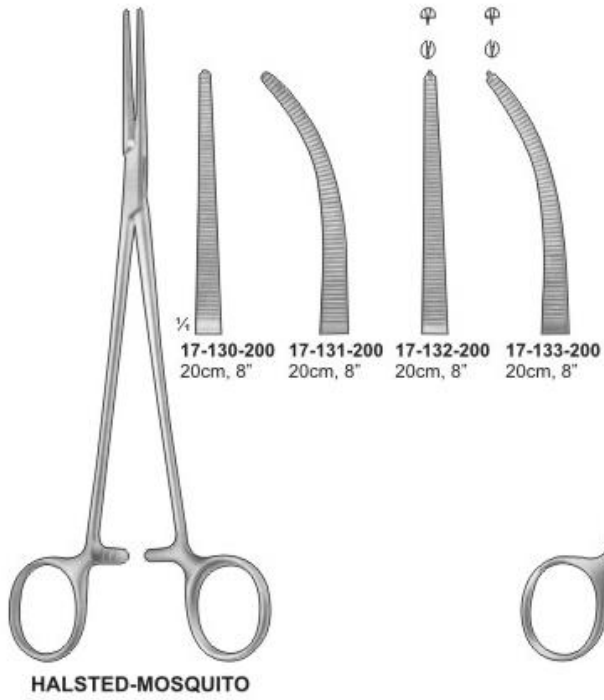



OVERHOLT-GEISSENDOERFER

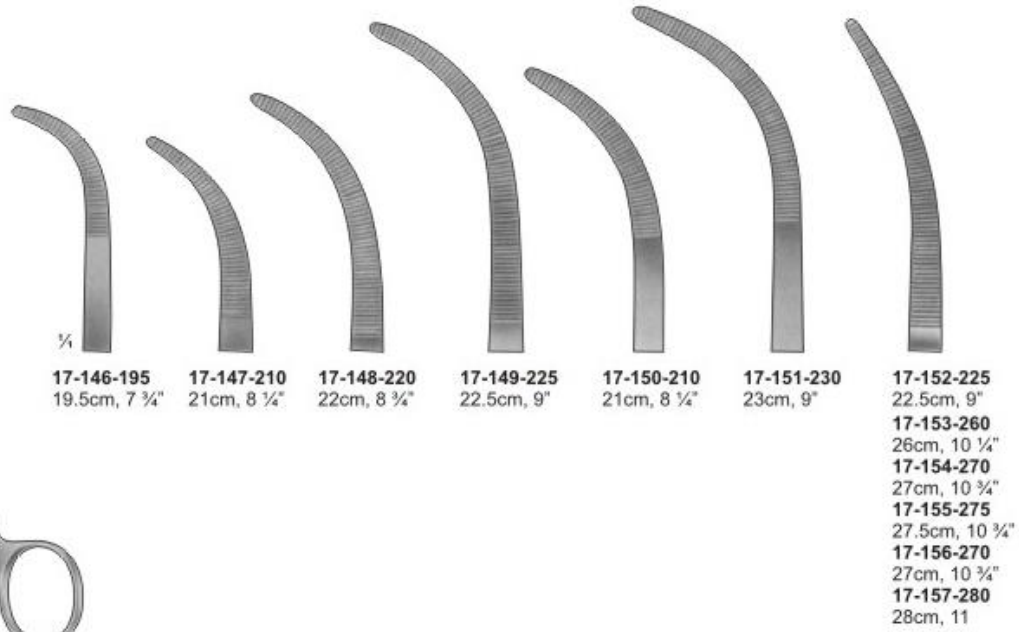

- | | | | | | | | | | | | |
|-------------------------------------|-----------------------------------|-----------------------------------|---------------------------------|-----------------------------------|-------------------------------|---------------------------------|------------------------------------|------------------------------------|--------------------------------------|------------------------------------|--------------------------------|
| 17-146-195
19.5cm, 7 3/4" | 17-147-210
21cm, 8 1/4" | 17-148-220
22cm, 8 3/4" | 17-149-225
22.5cm, 9" | 17-150-210
21cm, 8 1/4" | 17-151-230
23cm, 9" | 17-152-225
22.5cm, 9" | 17-153-260
26cm, 10 1/4" | 17-154-270
27cm, 10 3/4" | 17-155-275
27.5cm, 10 3/4" | 17-156-270
27cm, 10 3/4" | 17-157-280
28cm, 11" |
|-------------------------------------|-----------------------------------|-----------------------------------|---------------------------------|-----------------------------------|-------------------------------|---------------------------------|------------------------------------|------------------------------------|--------------------------------------|------------------------------------|--------------------------------|

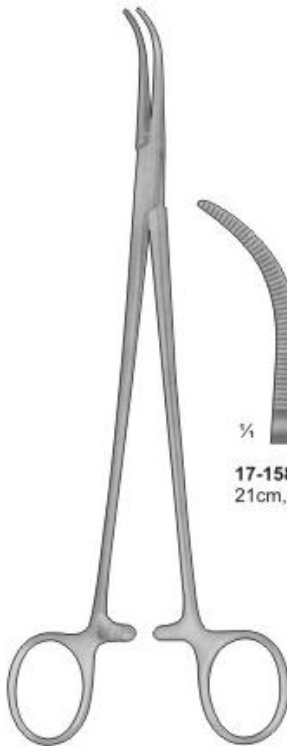

OVERHOLT
Fine Pattern

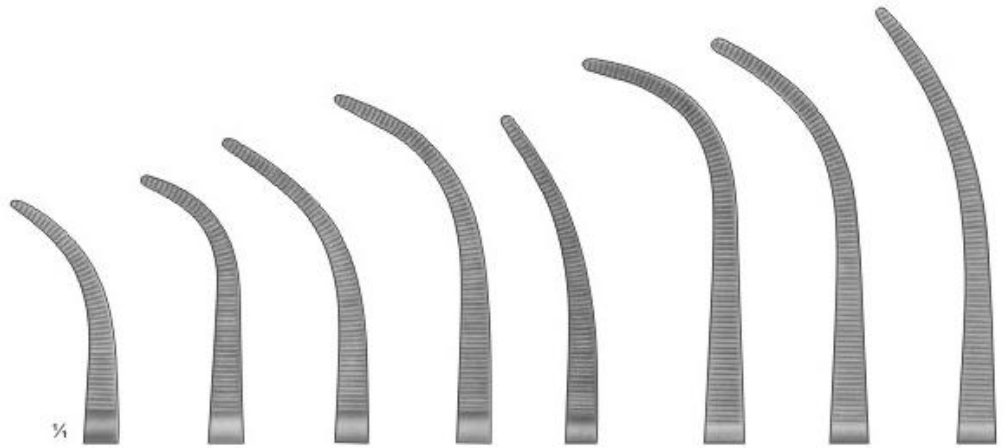

- | | | | | | | | |
|-----------------------------------|-------------------------------------|-----------------------------------|---------------------------------|---------------------------------|--------------------------------------|--------------------------------------|--------------------------------|
| 17-158-210
21cm, 8 1/4" | 17-159-215
21.5cm, 8 3/4" | 17-160-220
22cm, 8 3/4" | 17-161-225
22.5cm, 9" | 17-162-225
22.5cm, 9" | 17-163-295
29.5cm, 11 3/4" | 17-164-295
29.5cm, 11 3/4" | 17-165-300
30cm, 12" |
|-----------------------------------|-------------------------------------|-----------------------------------|---------------------------------|---------------------------------|--------------------------------------|--------------------------------------|--------------------------------|

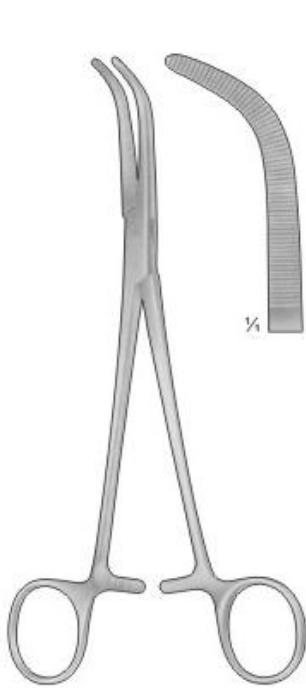

MIXTER-O'SHAUGNESSY
17-166-190
19cm, 7 1/2"

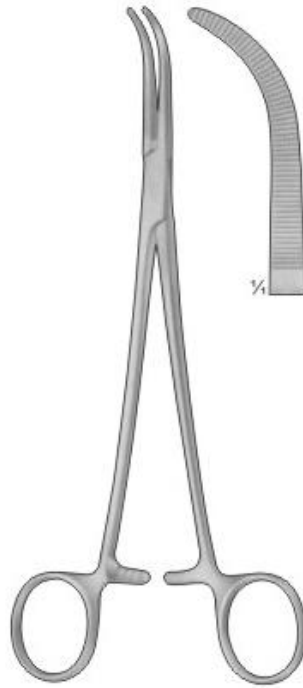

HEISS
17-167-195
19.5cm, 7 3/4"

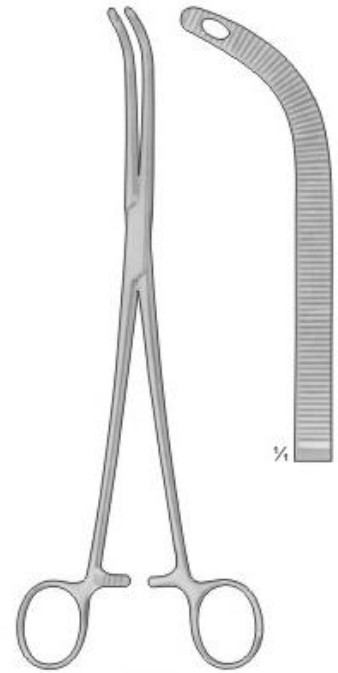

FINOCHIETTO
17-168-245
24.5cm, 9 1/2"

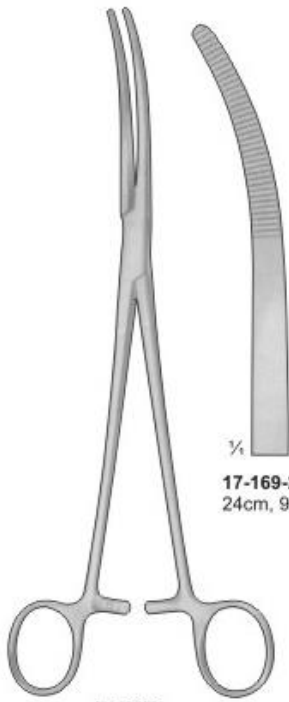

RUMEL



17-169-245
24cm, 9 1/2"



17-170-245
24cm, 9 1/2"



17-171-245
24cm, 9 1/2"



17-172-245
24cm, 9 1/2"



17-173-245
24cm, 9 1/2"

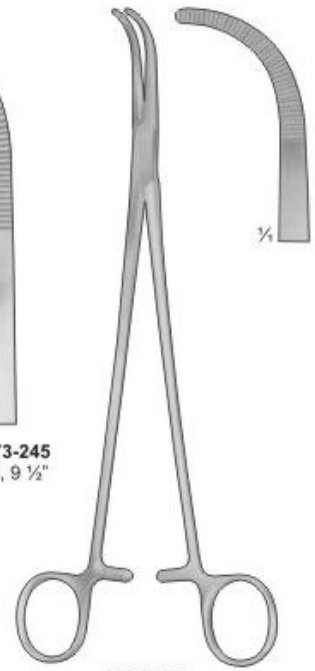

MIXTER
17-174-230
23cm, 9"



Hemostatic Forceps



MINI-GEMINI
curved, serrated



17-175-180
18 cm, 7"



17-176-220
22 cm, 8 1/4"



17-177-250
25 cm, 10"

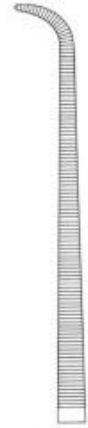

17-178-280
28 cm, 11"



GEMINI
Curved, Serrated

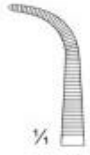

17-179-130
13 cm, 5"

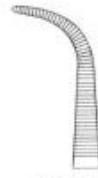

17-180-160
16 cm, 6 1/4"



17-181-180
18 cm, 7"

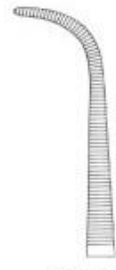

17-182-200
20 cm, 8"



17-183-230
23 cm, 9"



17-184-250
25 cm, 10"



17-185-280
28 cm, 11"

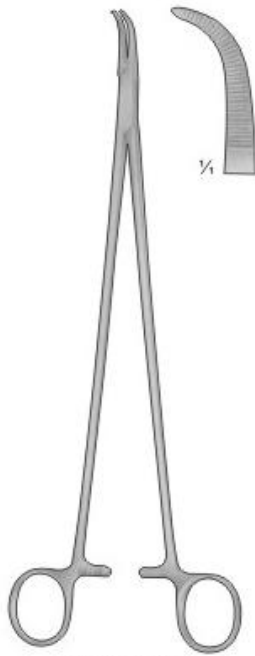

LAWRENCE
17-186-270
27cm, 10 3/4"

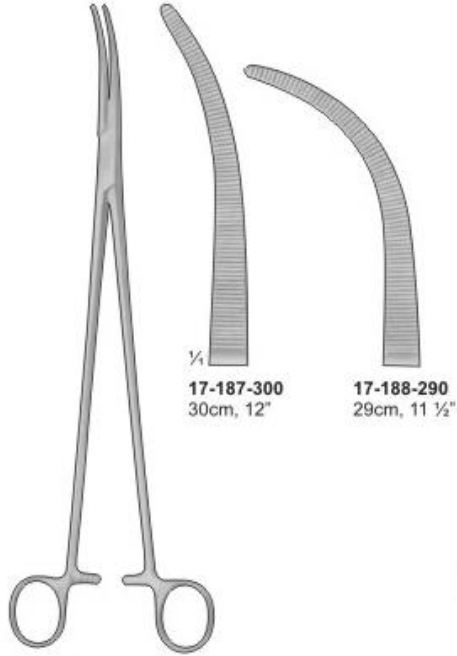

17-187-300
30cm, 12"

17-188-290
29cm, 11 1/2"

ZENKER

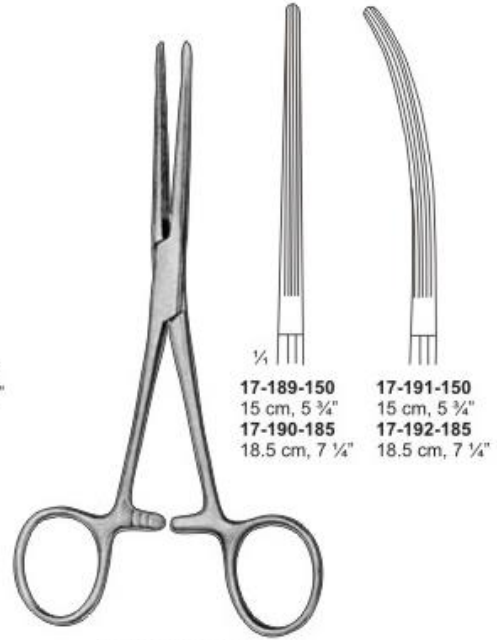

17-189-150
15 cm, 5 3/4"
17-190-185
18.5 cm, 7 1/4"

17-191-150
15 cm, 5 3/4"
17-192-185
18.5 cm, 7 1/4"

BAINBRIDGE



BRIDGE
17-193-280
28 cm, 11"
Curved, Serrated



LAWRENCE
17-194-280
28.0 cm, 11"

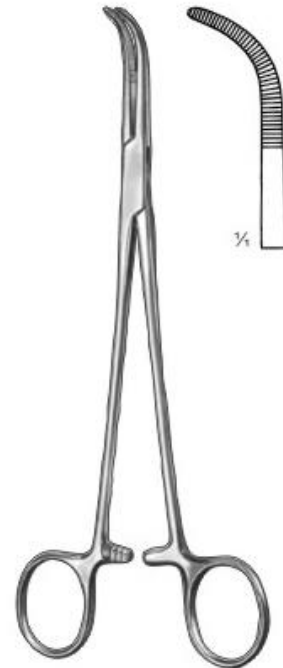

KANTROWITZ
17-195-200 20 cm, 8"
17-196-240 24 cm, 9 1/2"
17-197-280 28 cm, 11"
Right Angle, Serrated



17-198-180
18 cm, 7"
S Curve,
Coarse
serration

DEAN-SHALLCROSS

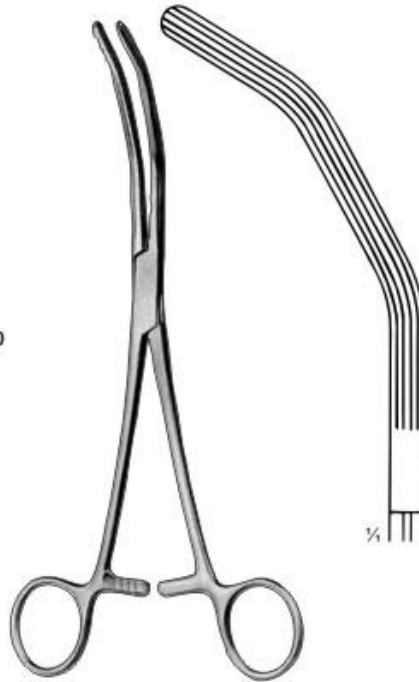

HERRICK
17-199-230
23.0 cm, 9"

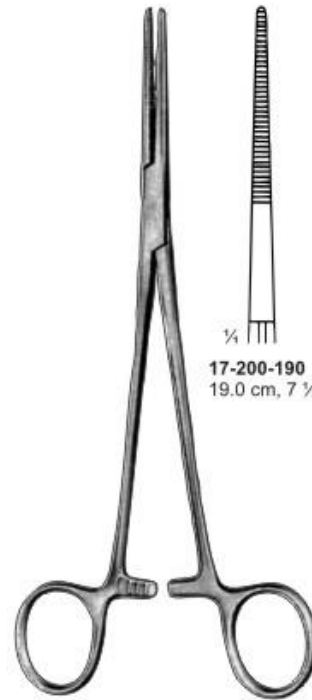

17-200-190
19.0 cm, 7 1/2"
17-201-190
19.0 cm, 7 1/2"

BIRKETT



CRAFOORD-SELLORS

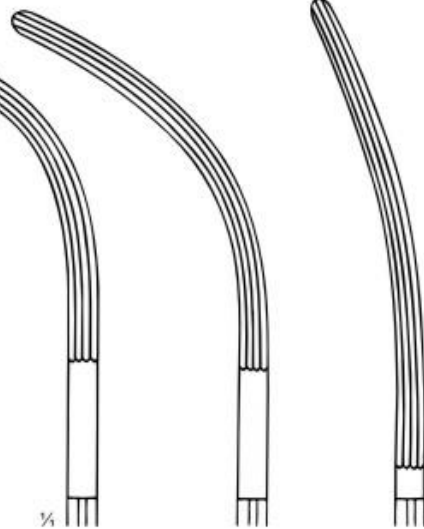

17-202-220
22.0 cm, 8 3/4"

17-203-230
23.0 cm, 9"

17-204-240
24.0 cm, 9 1/2"

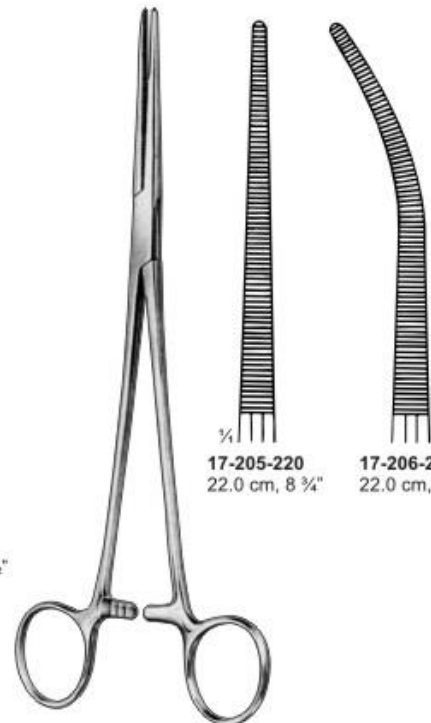

17-205-220
22.0 cm, 8 3/4"

17-206-220
22.0 cm, 8 3/4"

ROBERTS



WIKSTROEM
17-207-190
19.0 cm, 7 1/2"

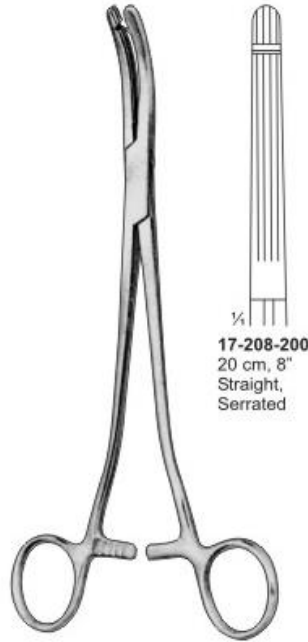

HEANEY / BALLANTINE



HEANEY / REZAK
17-210-210 21 cm, 8 1/4"
Straight, Cross Serrated

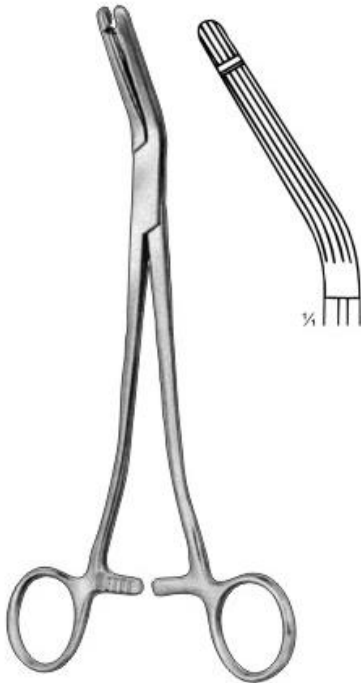

GARLAND
17-211-210
21 cm, 8 1/4"

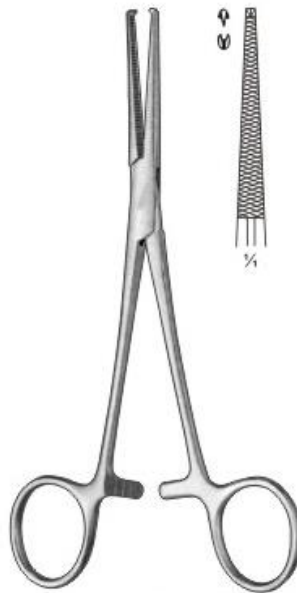

DIXON-LOVELACE 1:2
17-212-155 15.5 cm, 6"

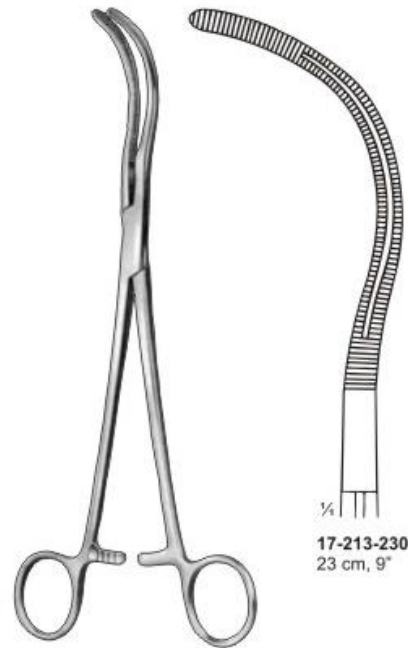

STILLE

17-213-230
23 cm, 9"

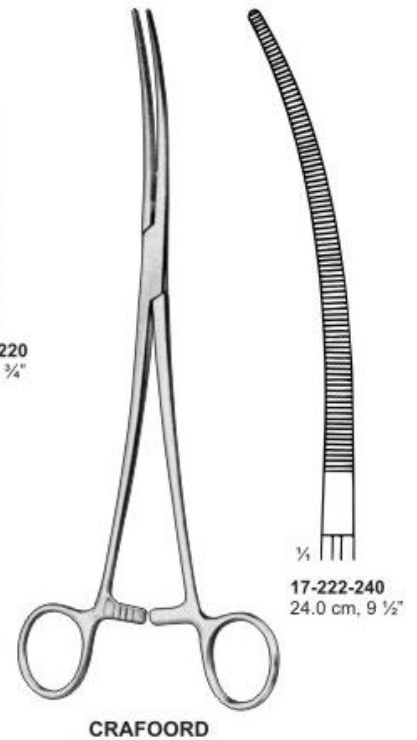
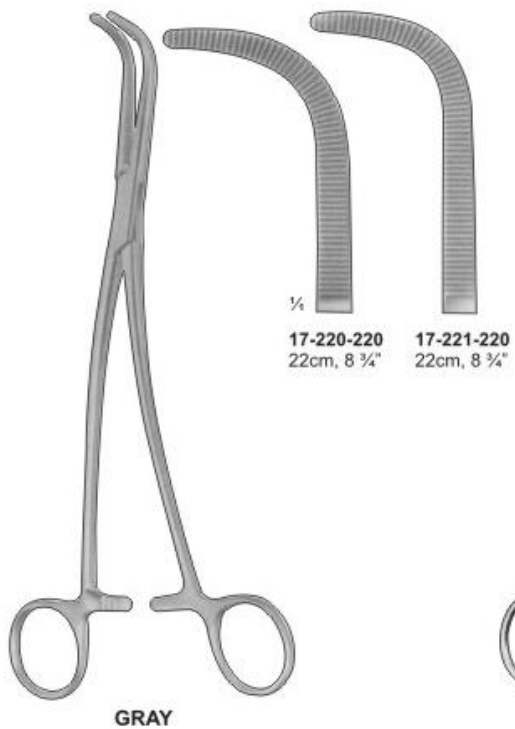
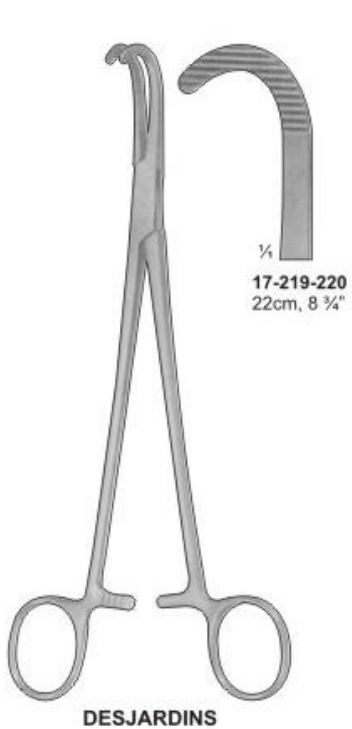
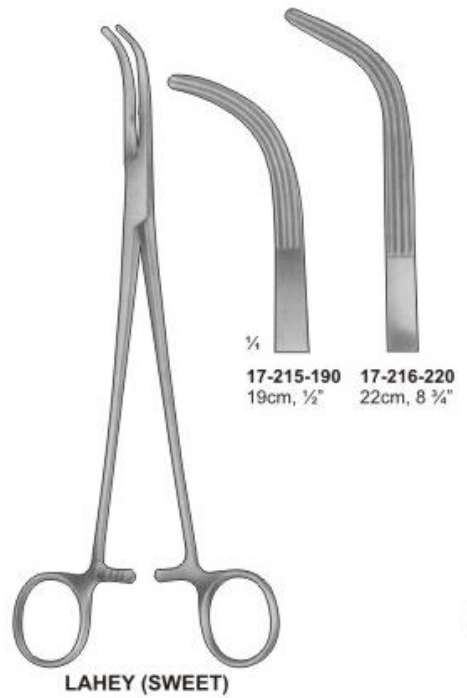
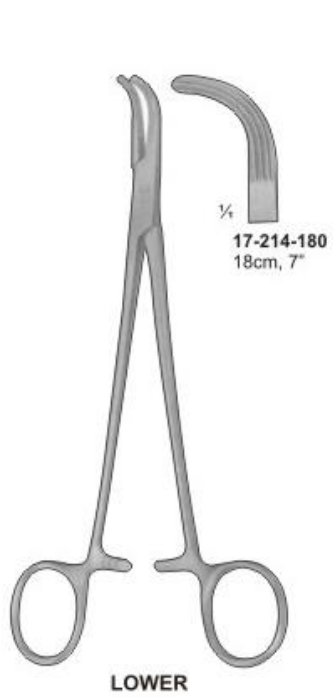

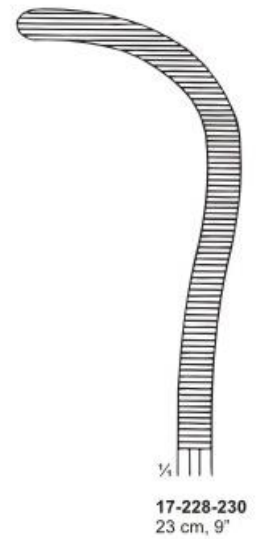
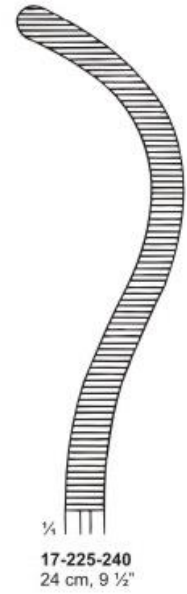



Hemostatic Forceps

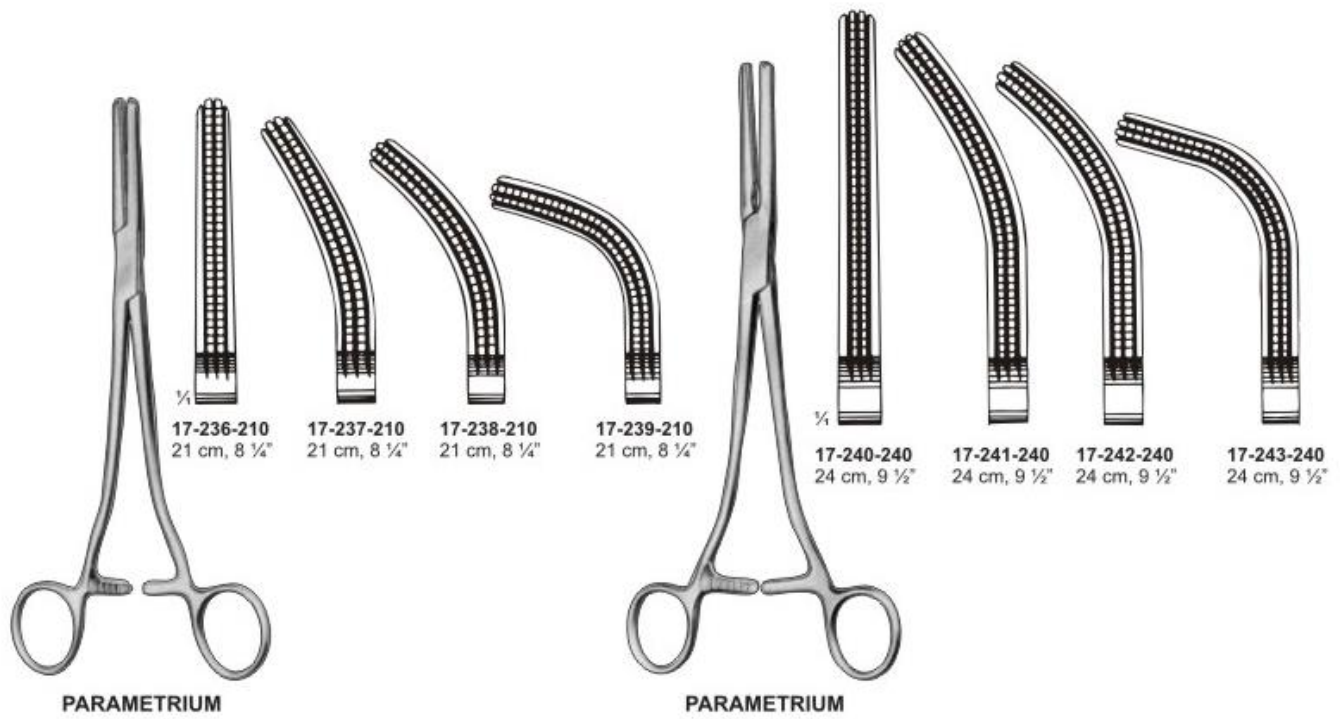
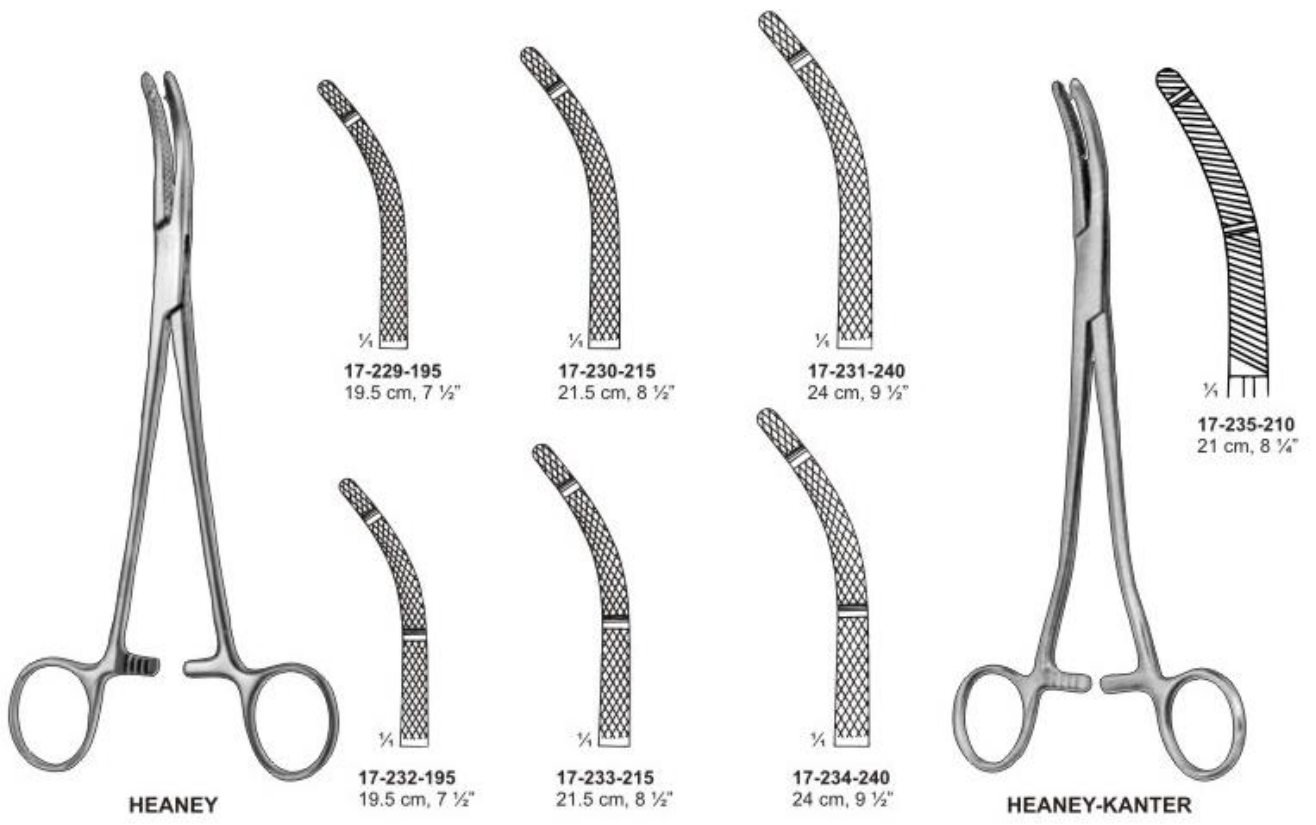

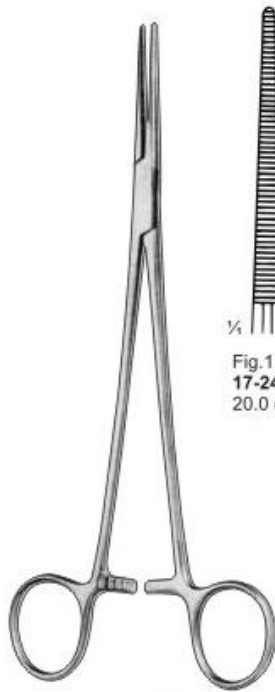

HEISS



Fig.1
17-244-200
20.0 cm, 8"



Fig.2
17-245-200
20.0 cm, 8"



Fig.3
17-246-200
20.0 cm, 8"



JOHN HOPKINS



17-247-200
20.0 cm, 8"

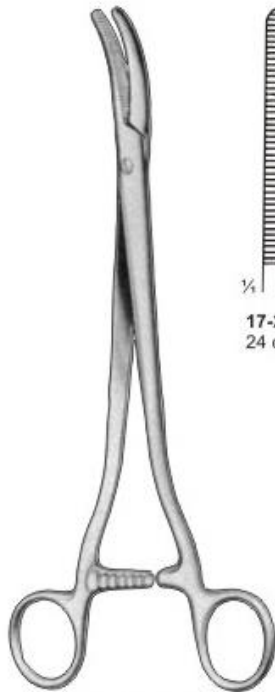

SEGOND-LANDAU



17-248-240
24 cm, 9 1/2"



17-249-240
24 cm, 9 1/2"



SCHINDLER 1:2

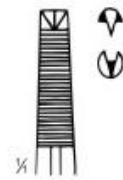

17-250-200
20 cm, 8"

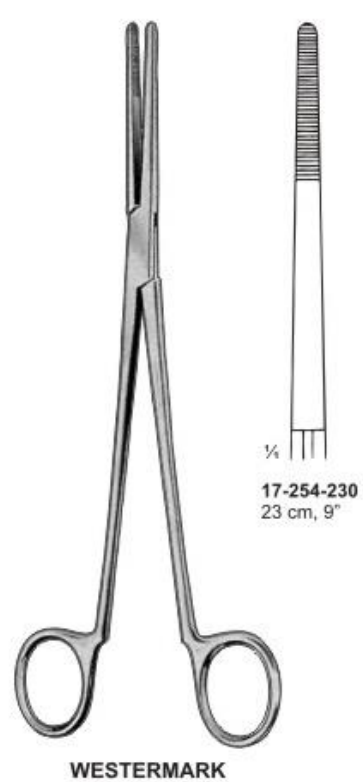
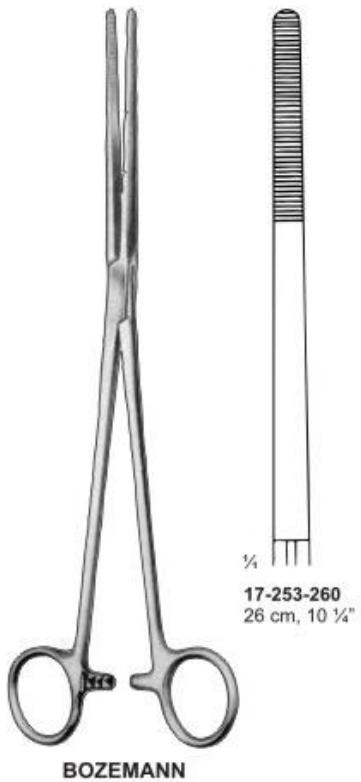
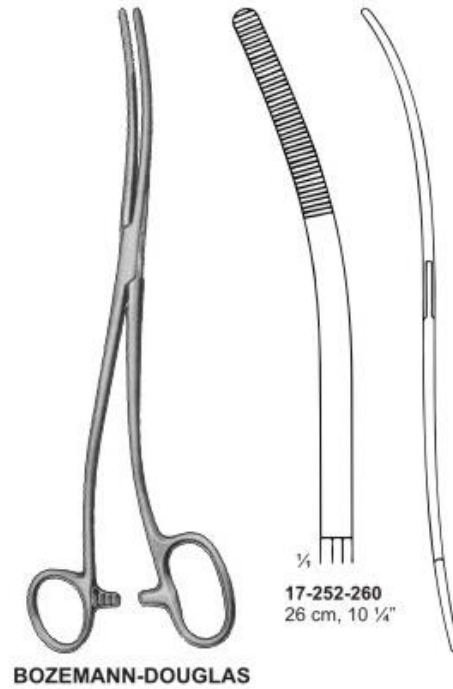
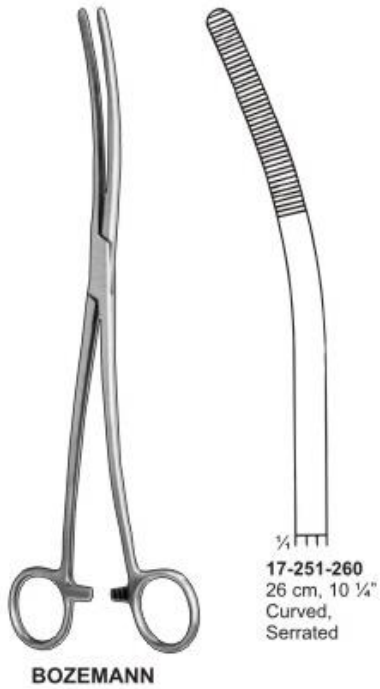



GRAY

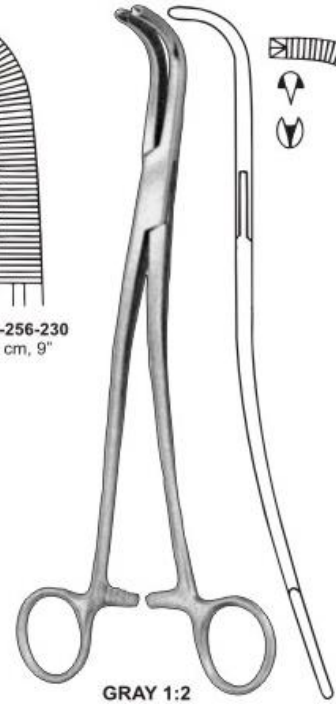
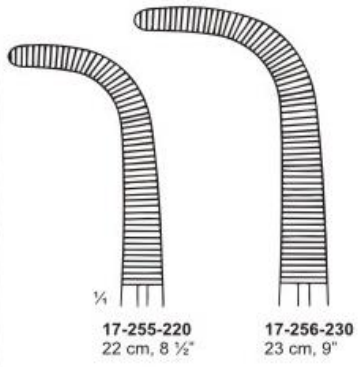

GRAY 1:2

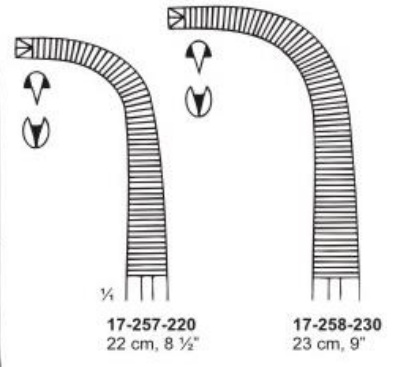

PHANEUF 1:2

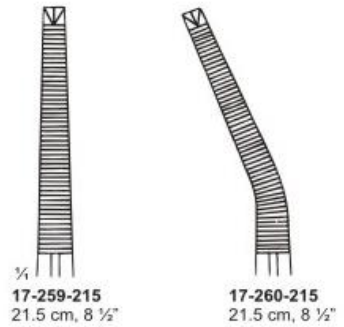

LONG
17-261-190
19.0 cm, 7 1/2"





Hemostatic Forceps



BABY-MIKULICZ
17-262-140
14cm, 5 1/2"

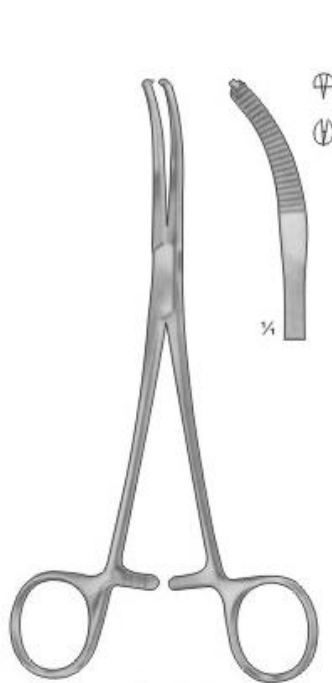

MIKULICZ
17-263-185
18.5cm, 7 1/4"

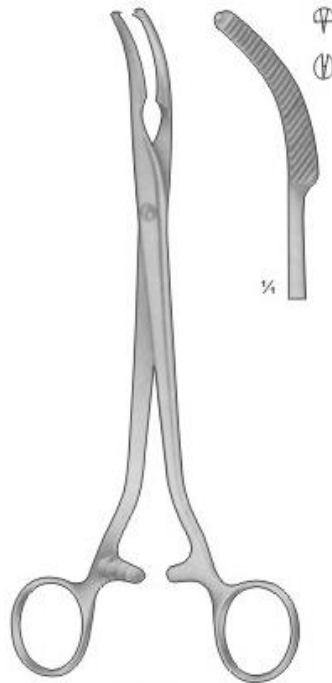

MIKULICZ
17-264-205
20.5cm, 8"

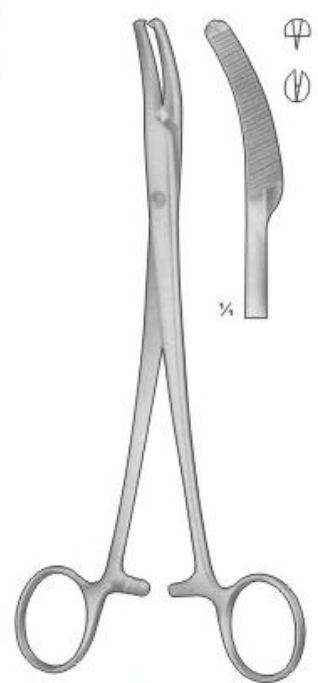

MIKULICZ
17-265-200
20cm, 8"

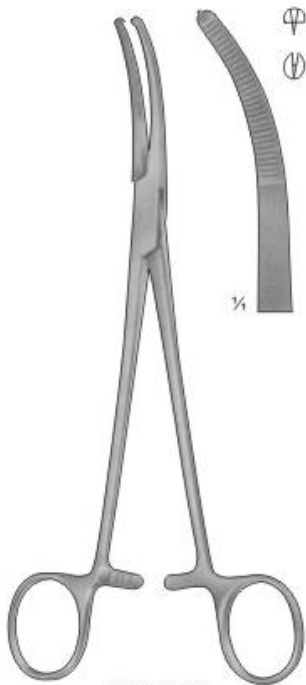

MIKULICZ
17-266-205
20.5cm, 8"

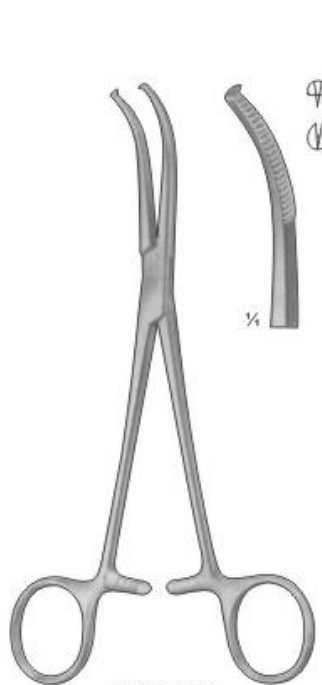

MIKULICZ
17-267-205
20.5cm, 8"

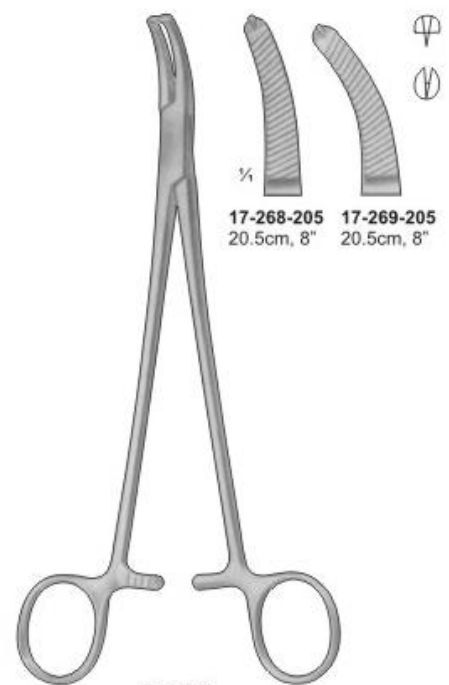

FAURE

17-268-205 20.5cm, 8"
17-269-205 20.5cm, 8"

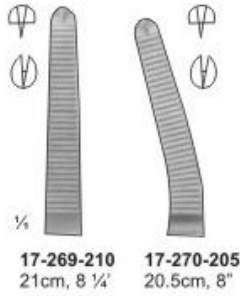
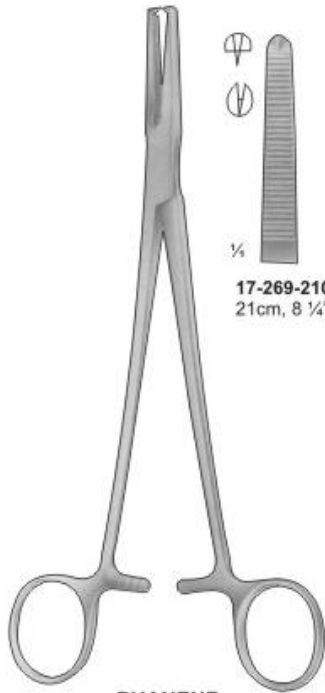

17-269-210
21cm, 8 1/4"
17-270-205
20.5cm, 8"

PHANEUF

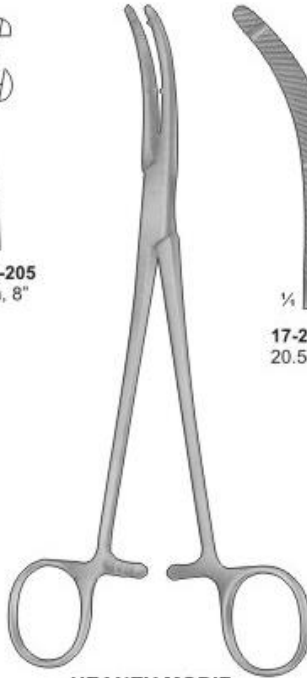

17-271-205
20.5cm, 8"
17-272-245
24.5cm, 9 1/4"

HEANEY MODIF.

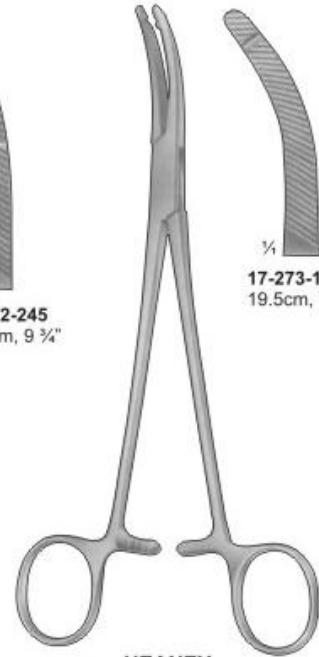

17-273-195
19.5cm, 7 3/4"

HEANEY

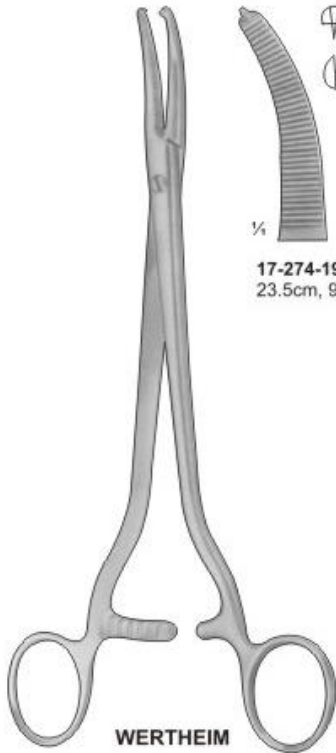

17-274-195
23.5cm, 9 1/4"

WERTHEIM

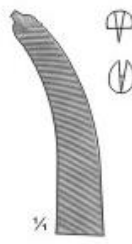
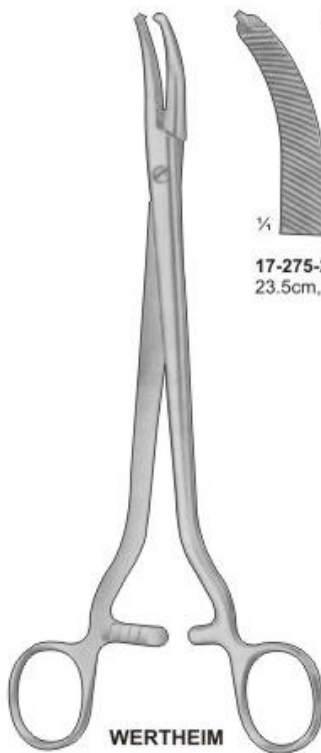

17-275-235
23.5cm, 9 1/4"

WERTHEIM

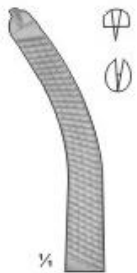

17-276-245
24.5cm, 9 1/4"

WERTHEIM

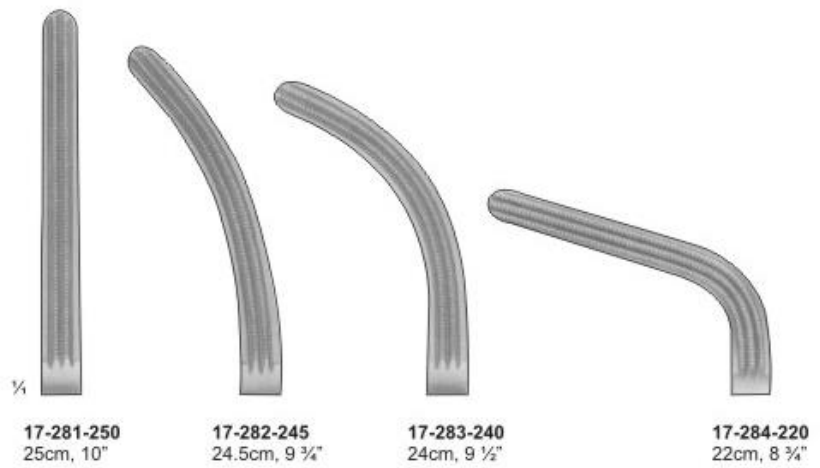
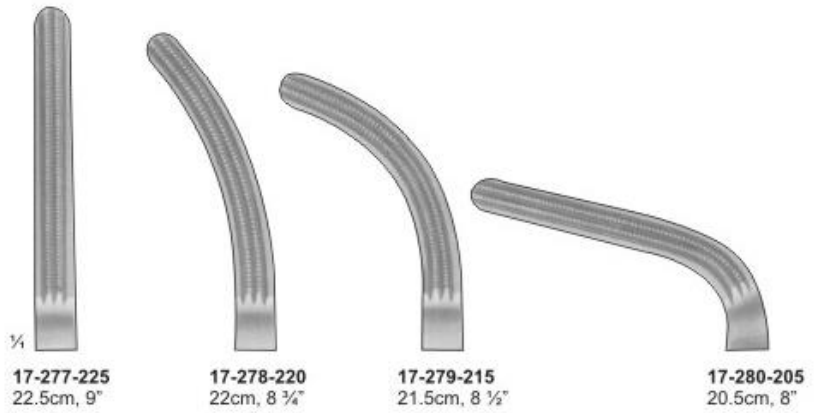

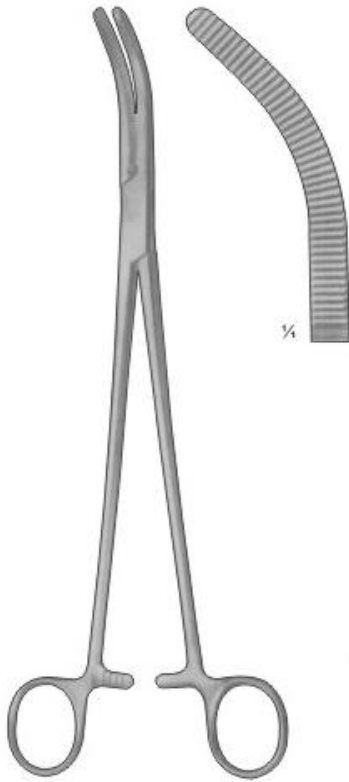

WERTHEIM
Hysterectomy Forceps
17-285-255
25.5cm, 10"

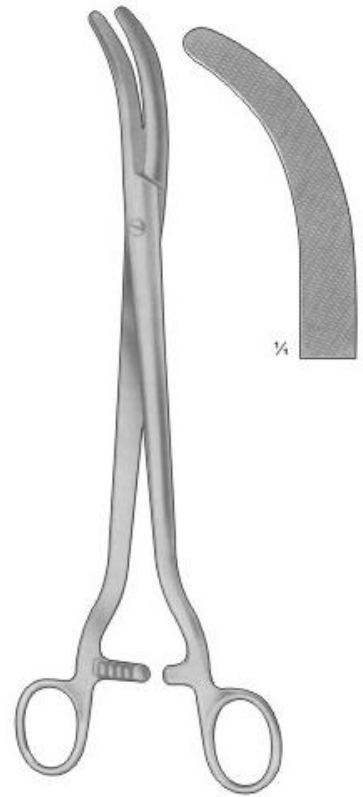

WERTHEIM
Parametrium Clamp
17-286-260
26cm, 10 1/4"

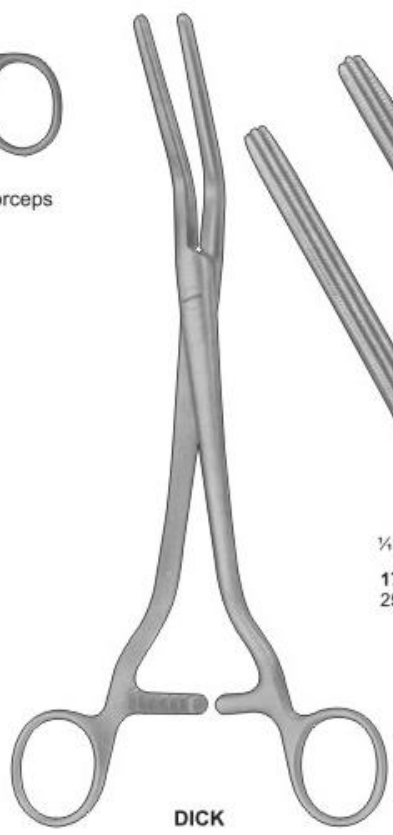

DICK



17-287-255
25.5cm, 10"



17-288-265
26.5cm, 10 1/4"



17-289-275
27.5cm, 10 3/4"

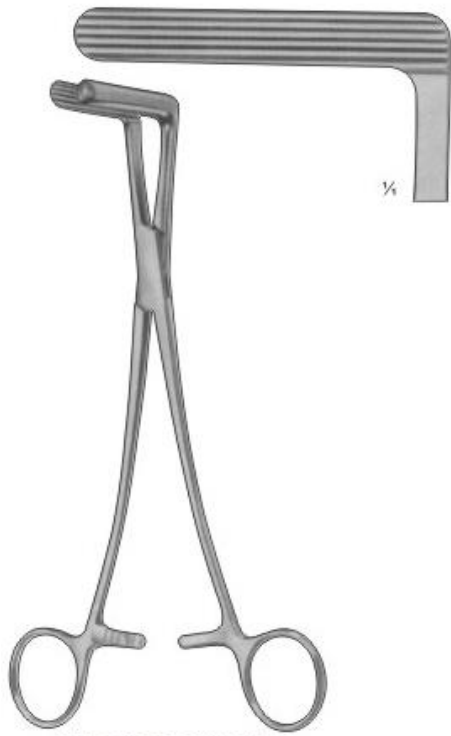

WERTHEIM-CULLEN
17-290-215
21.5cm, 8 1/2"



WERTHEIM-CULLEN
23cm, 9"

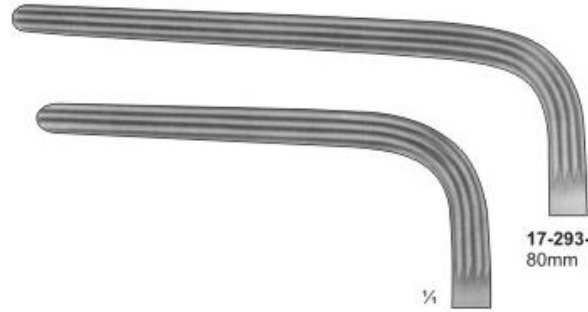

17-293-002
80mm

17-292-001
60mm

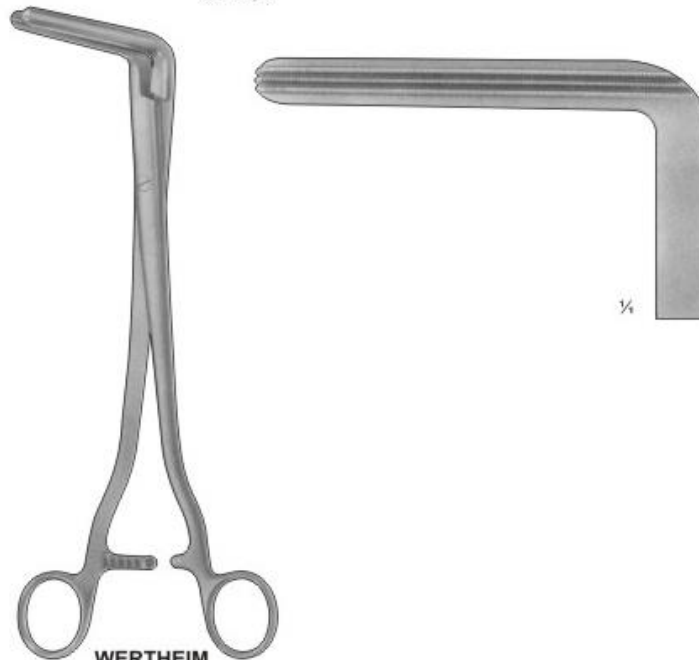

WERTHEIM
17-294-250
25cm, 10"

Towel Forceps



**JONES /
PERFORATING**
17-295-090
9 cm, 3 1/2"
Slight Curve



ENGL. MODELL
17-296-090
9 cm, 3 1/2"

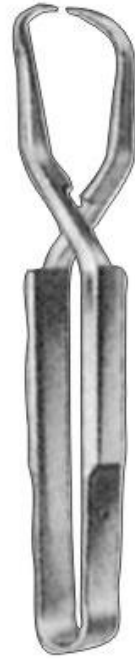

SCHAEDEL
17-297-090
9 cm, 3 1/2"



**THOMSON-WALKER'S
PENILE CLAMPS**
17-298-090
9 cm, 3 1/2"
Cross-Action model.



DOYEN
17-299-180
18 cm, 7"



BACKHAUS
17-300-080 8 cm, 3"
17-301-110 11 cm, 4 1/2"
17-302-130 13 cm, 5"
17-303-150 15 cm, 5 1/4"
Curved



ROEDER
17-304-130 13 cm, 5"
17-305-150 15 cm, 6"
Curved, Serrated

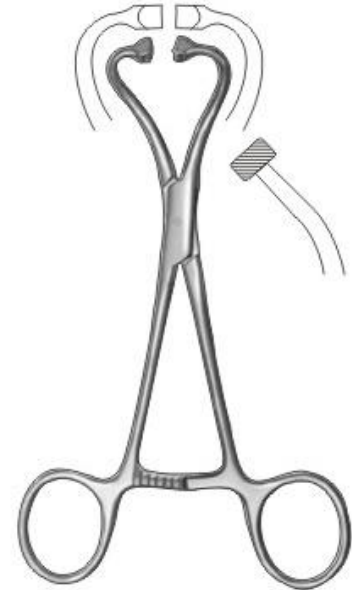

NON-PERFORATING
17-306-110 11 cm, 4 1/2"
17-307-130 13 cm, 5"

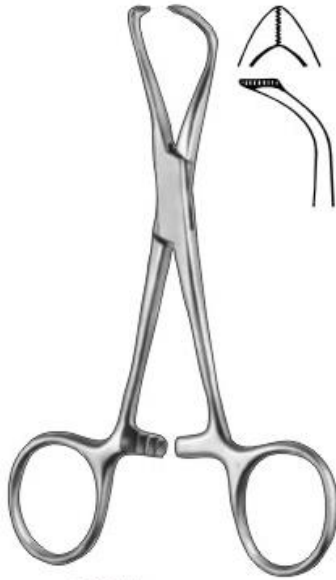

LORNA
 17-308-100 10 cm, 4"
 17-309-110 11 cm, 4 1/2"
 17-310-130 13 cm, 5"



BACKHAUS CLIP
 17-311-110 11 cm, 4 1/2"
 with clip for tubing or cable



BALL & SOCKET
 17-312-130 13 cm, 5"
 Non-perforating

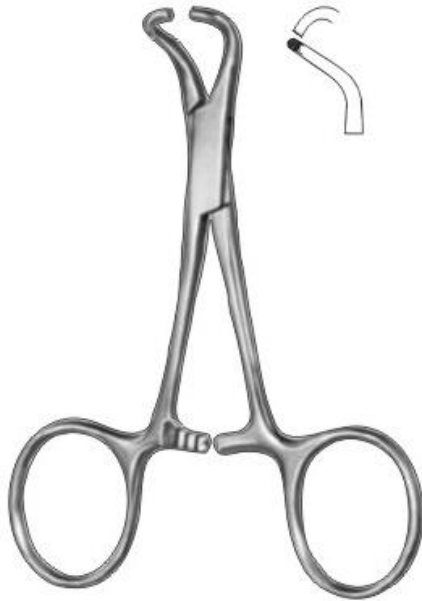

TOHOKU
 17-313-100 10cm, 4"
 17-314-130 13cm, 5"
 Non-Perforating

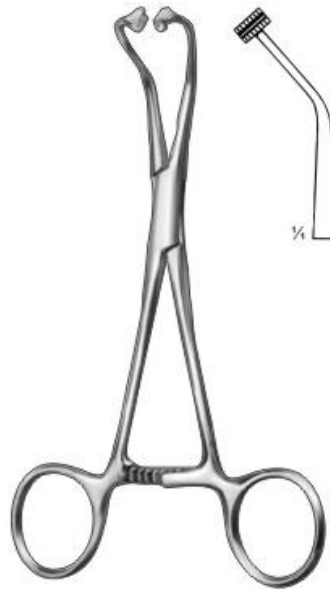

PEERS-BERTMAN
 17-315-145
 14.5 cm, 5 3/4"
 Serrated



BERNHARD
 17-316-165
 16.5 cm, 6 1/2"

Tubing Clamps

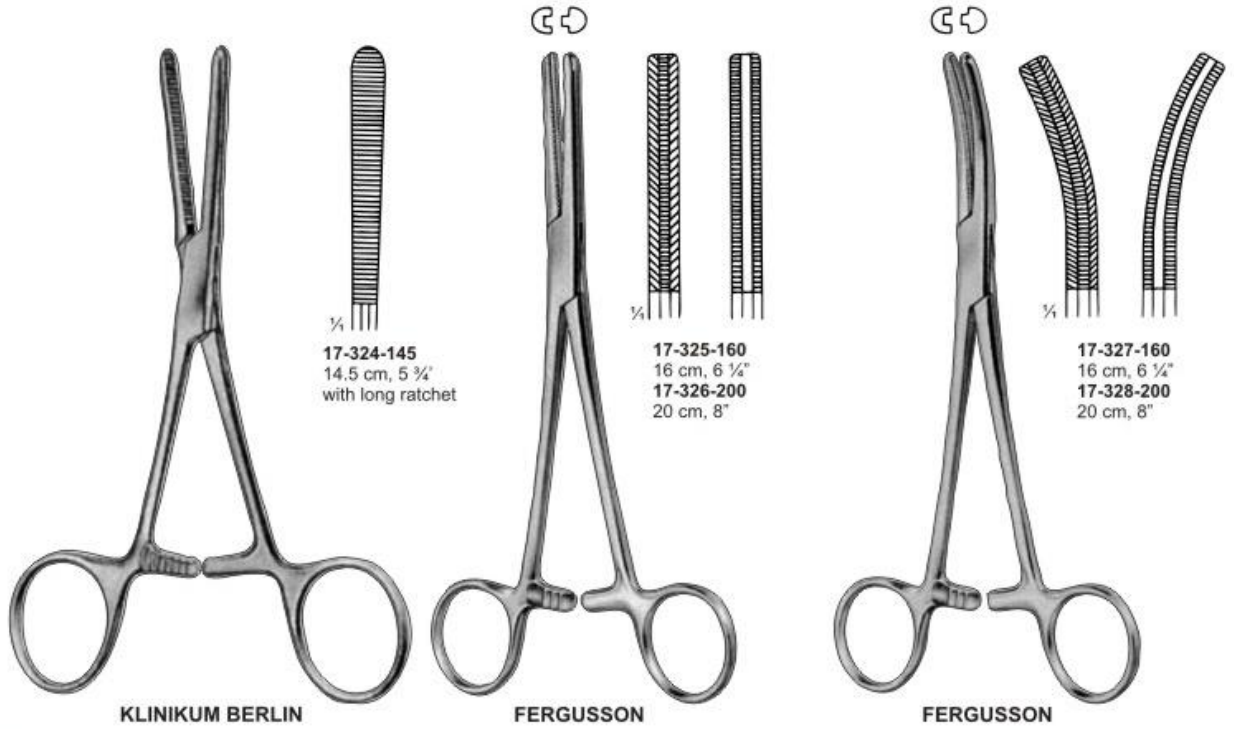
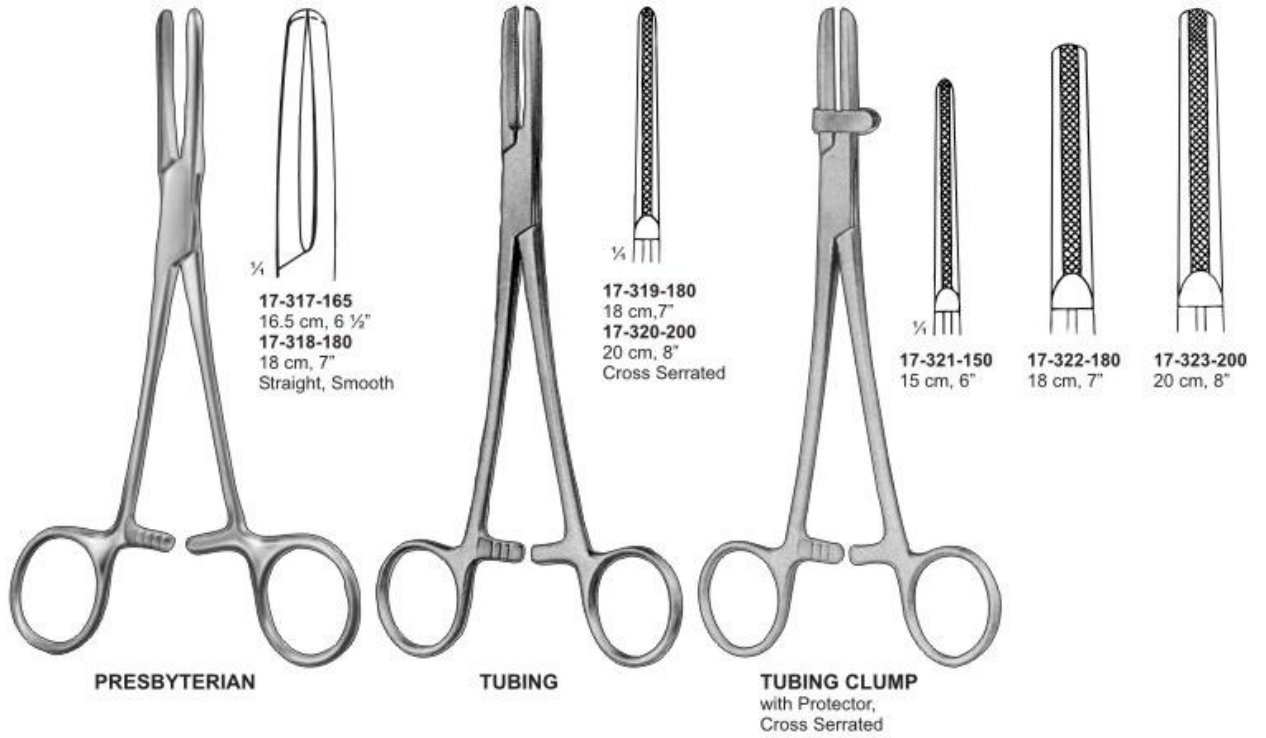

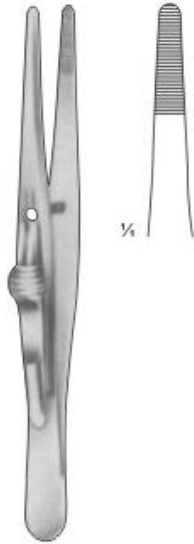

FRICKE
Artery Forceps
17-329-130
13cm, 5 1/4"

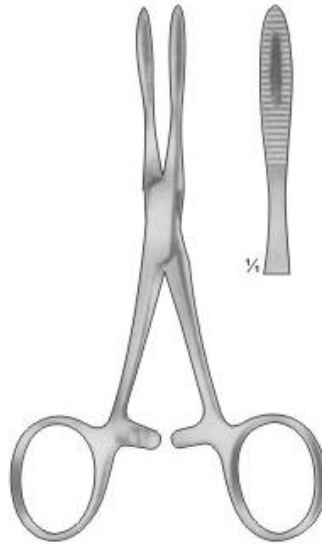

KRONLENIN
17-330-130
13cm, 5 1/4"

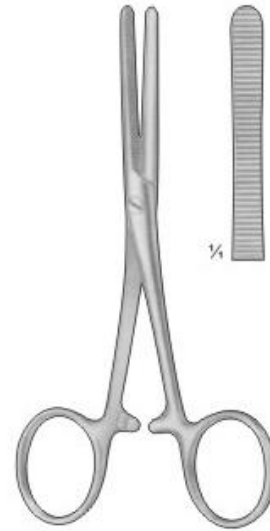

PEAN
17-331-125
12.5cm, 4 3/4"

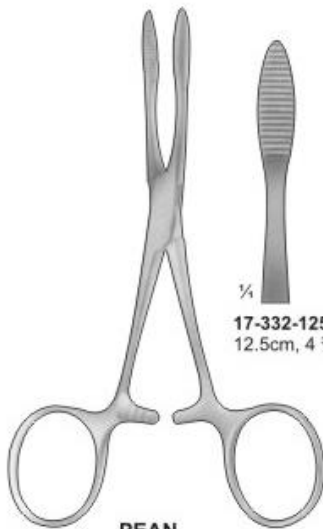

17-332-125
12.5cm, 4 3/4"

PEAN

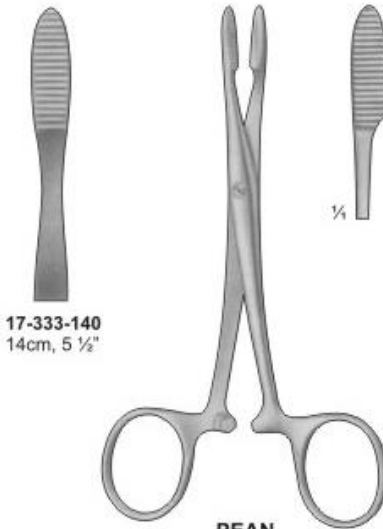

PEAN
17-334-125



17-333-140
14cm, 5 1/2"

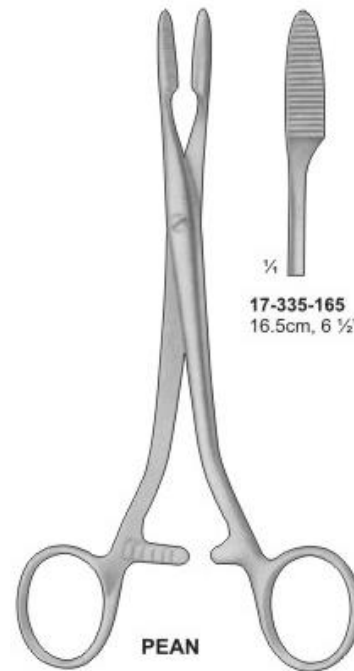

17-335-165
16.5cm, 6 1/2"

PEAN



17-336-185
18.5cm, 7 1/4"

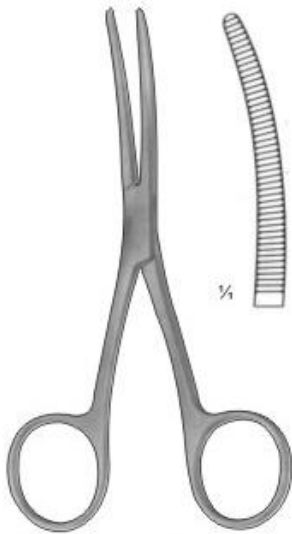

BRYANT
17-337-130
13cm, 5 1/4"

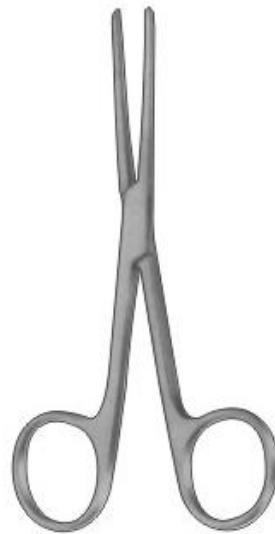

LISTER
Sinus Forceps



17-338-130
13cm, 5 1/4"

17-339-155
15.5cm, 6"

17-340-175
17.5cm, 7"

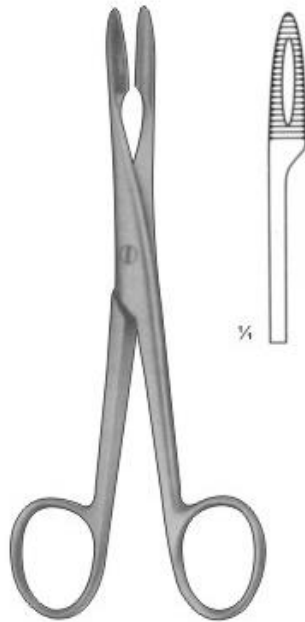

With Ratchet
17-341-145
14.5cm, 5 3/4"

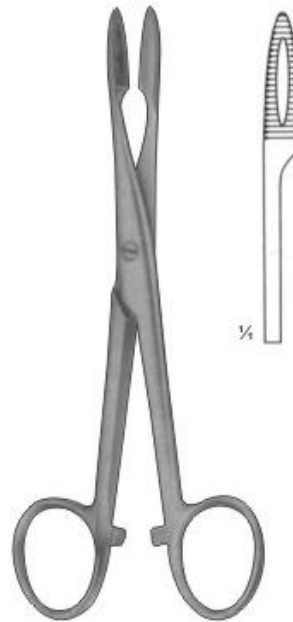

With Ratchet
17-342-145
14.5cm, 5 3/4"

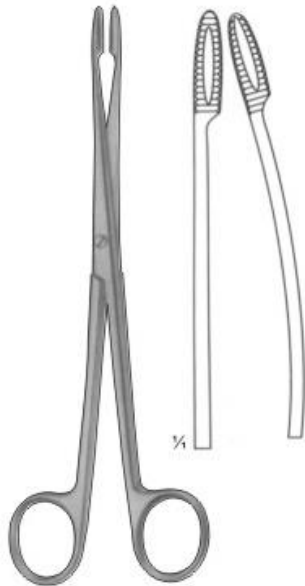

GROSS
With Ratchet
17-343-200
20cm, 8"

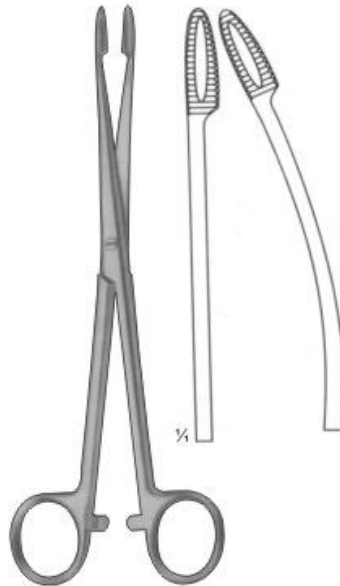

GROSS
With Ratchet
17-344-180
18cm, 7"

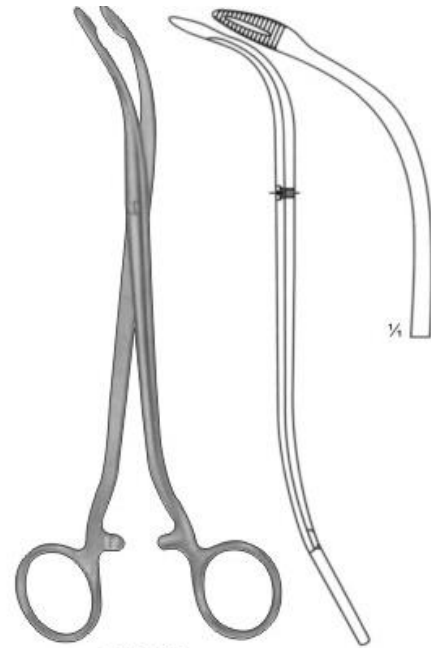

DUPLAY
17-345-190
19cm, 7 1/2"

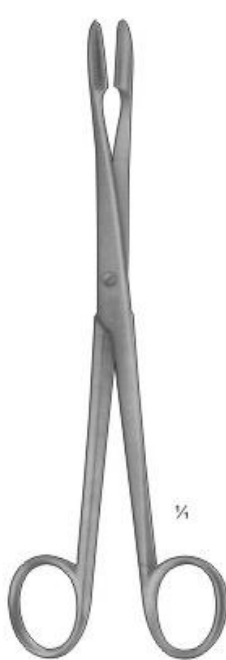

GROSS
Without Ratchet
17-346-200
20cm, 8"

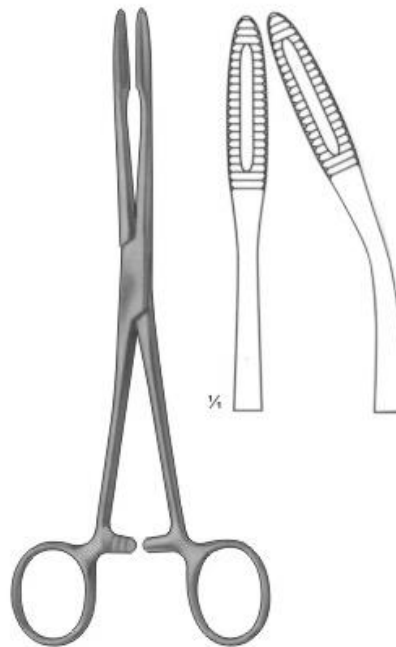
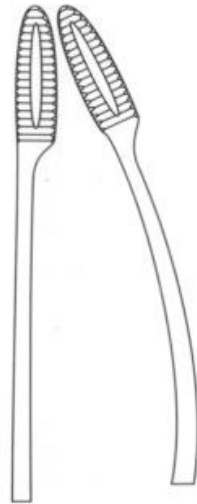

GROSS
With Ratchet
17-347-200
20cm, 8"



TUFFIER
17-348-130
13.0 cm, 5"

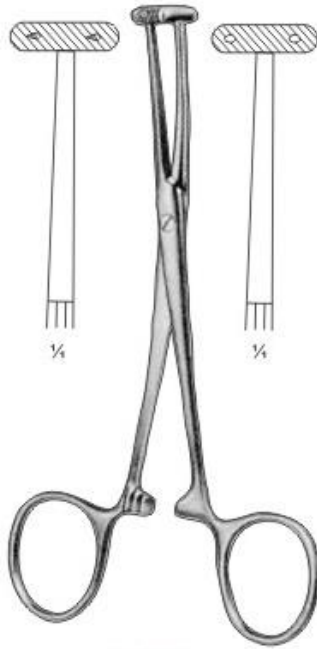

MARTEL
17-349-140
14.0 cm, 5 1/2"

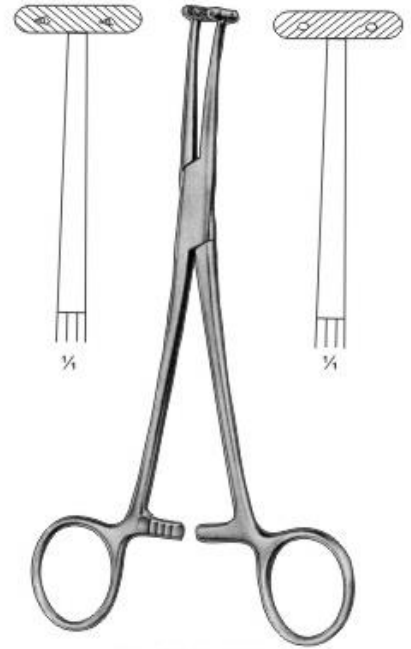

WILLET-MARTEL
17-350-190
19.0 cm, 7 1/2"



PRATT

17-351-150
15 cm, 4 3/4"
Slight Curve

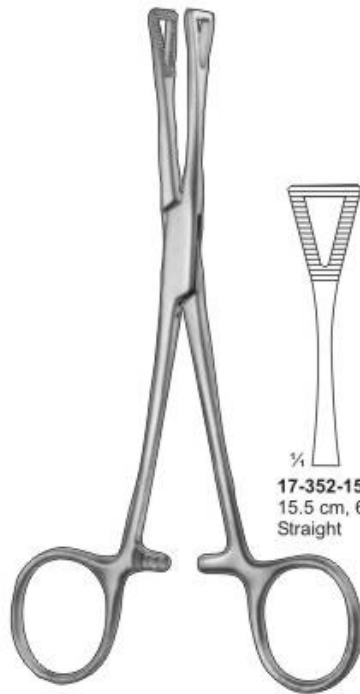

PENNINGTON / SIEZING

17-352-155
15.5 cm, 6"
Straight

17-353-200
20 cm, 8"
Straight



CHAPUT
17-354-130
13.0 cm, 5"



Hemostatic Forceps

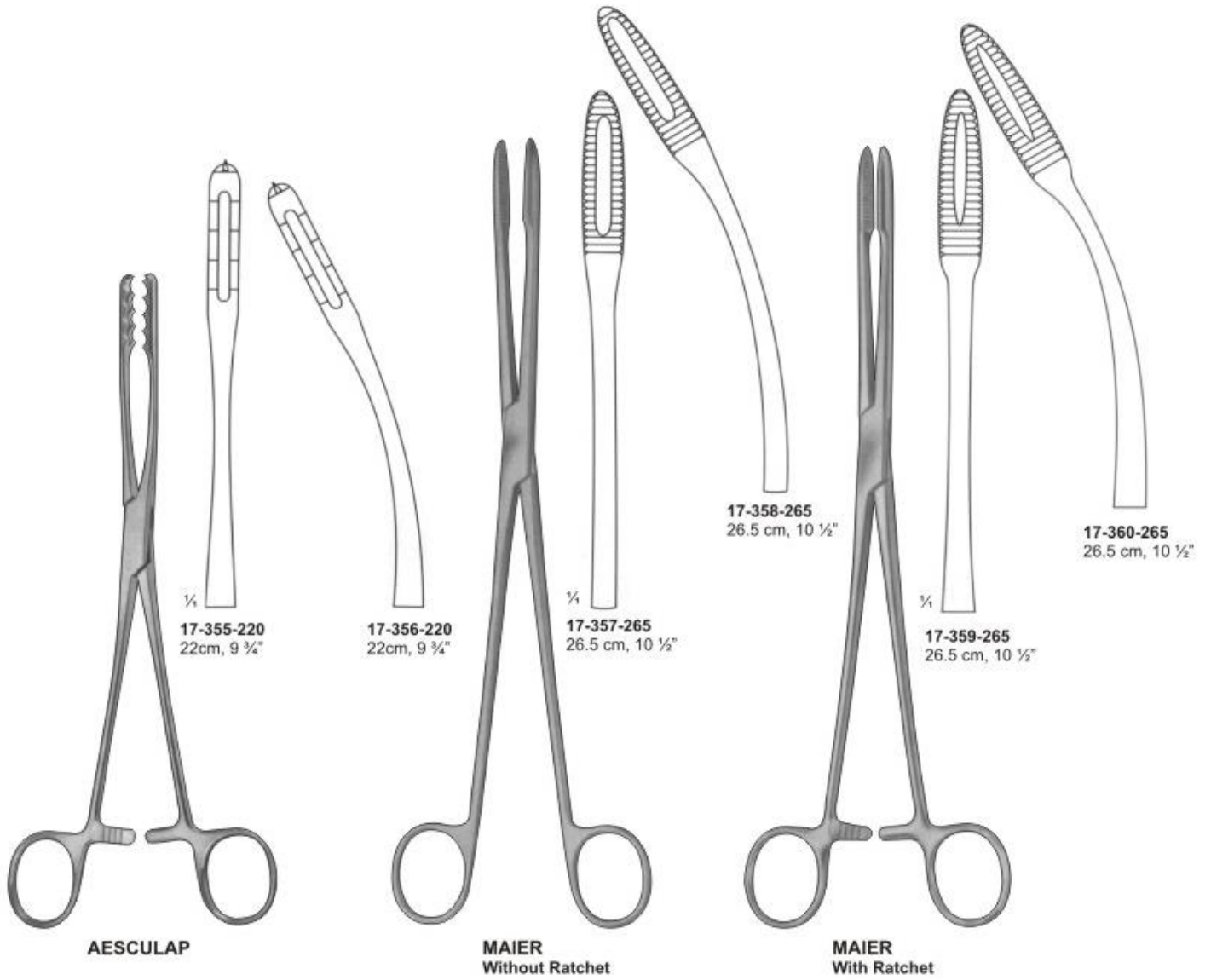

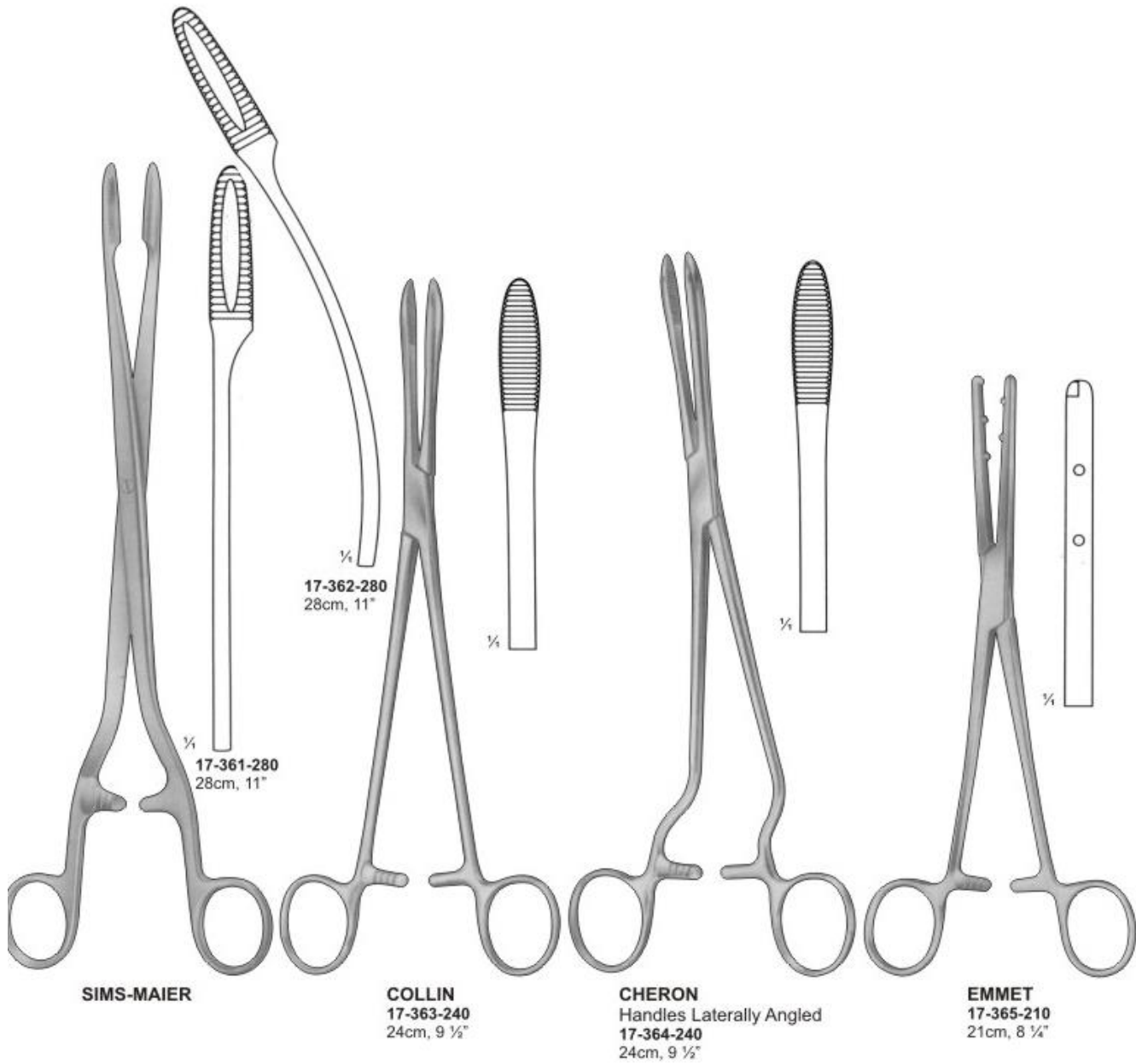

Tendon seizing forceps



17-366-155
15.5 cm, 6"

HERZ



17-367-155
15.5 cm, 6"

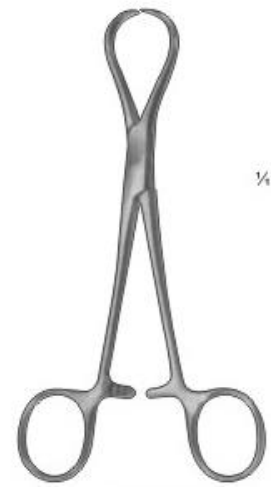

JACKSON

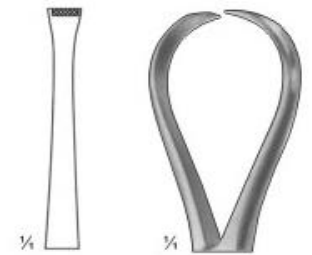

17-368-150
4 x 5 teeth
15 cm, 6"

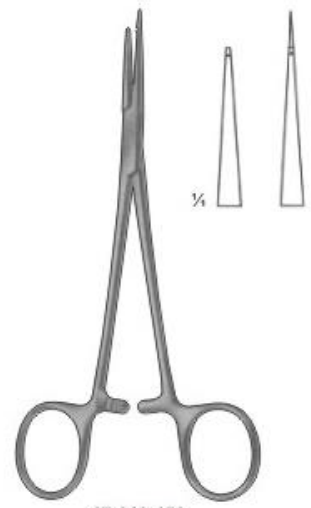

17-369-150
15cm, 6"

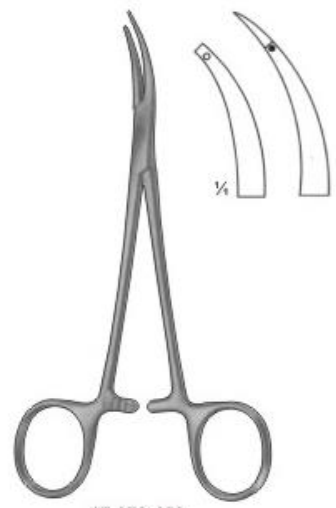

17-370-150
15cm, 6"

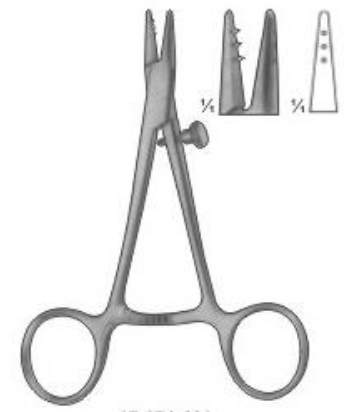

17-371-120
12cm, 5"



JAGER
17-372-275
Tendon and cross ligament
passing forceps
flexible shaft
27.5cm, 10 3/4"



Hemostatic Forceps

Sponge Forceps



17-373-220
22 cm, 8 3/4"

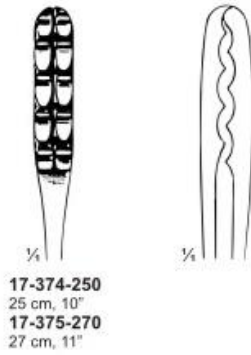

17-376-220
22 cm, 8 3/4"





17-382-250
25 cm, 10"

PELKMANN



17-383-250
25 cm, 10"

PELKMANN



17-384-205
20.5 cm, 8"

DUPLAY

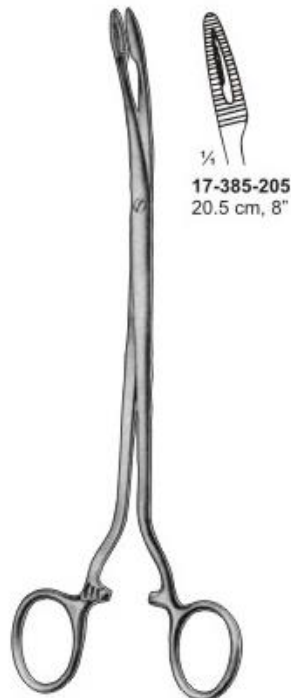

17-385-205
20.5 cm, 8"

DUPLAY

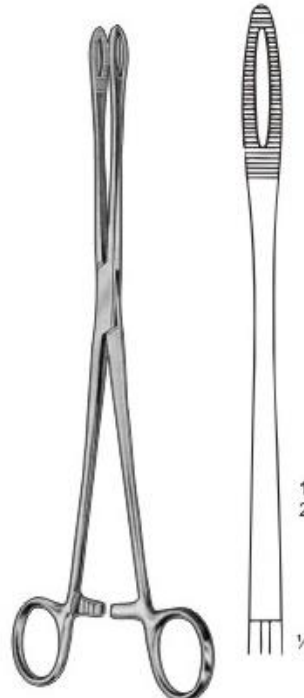

17-386-250
25 cm, 10"

FOERSTER-BALLENGER

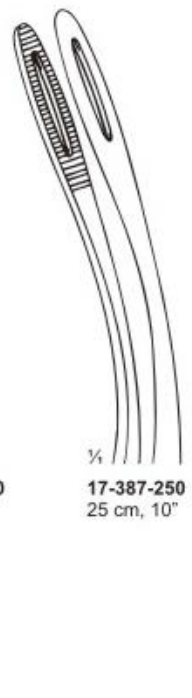

17-387-250
25 cm, 10"



Hemostatic Forceps

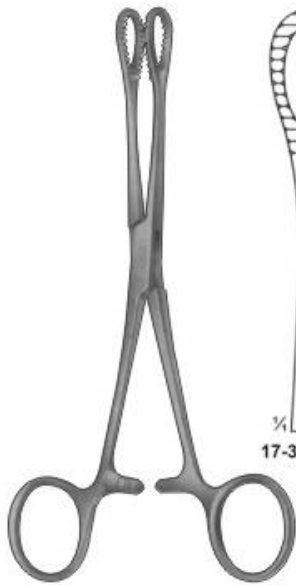

FOERSTER-BALLENGER
17-388-180
18cm, 7"



17-389-180



17-390-180



RAMPLEY
17-391-180



17-392-180
18cm, 7"



17-393-250
25cm, 10"



FOERSTER



17-394-25
25.0cm 10"
Round



17-395-18
18.0cm 7"
17-396-20
20.0cm 8"
17-397-25
25.0cm 10"
Round



17-398-25
25.0cm 10"
Round

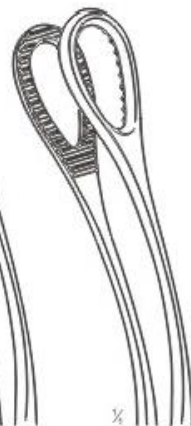

17-399-18
18.0cm 7"
17-400-20
20.0cm 8"
17-401-25
25.0cm 10"
Round



Hemostatic Forceps

